



Cosmic Microwave Background as a Probe of the Very Early Universe

Eiichiro Komatsu (Texas Cosmology Center, UT Austin)
Solvay Colloquium, Solvay Institutes, May 12, 2009

The Question

- How much do we understand our Universe?

The Question

- How much do we understand our Universe?
 - How old is it?

The Question

- How much do we understand our Universe?
 - How old is it?
 - How big is it?

The Question

- How much do we understand our Universe?
 - How old is it?
 - How big is it?
 - What shape does it take?

The Question

- How much do we understand our Universe?
 - How old is it?
 - How big is it?
 - What shape does it take?
 - What is it made of?

The Question

- How much do we understand our Universe?
 - How old is it?
 - How big is it?
 - What shape does it take?
 - What is it made of?
 - How did it begin?

The Question

- How much do we understand our Universe?
 - How old is it?
 - How big is it?
 - What shape does it take?
 - What is it made of?
 - ***How did it begin?***

The Breakthrough

- Now we can **observe** the physical condition of the Universe when it was very young.

Cosmic Microwave Background (CMB)

- Fossil light of the Big Bang!



From "Cosmic Voyage"

Night Sky in Optical ($\sim 0.5\mu\text{m}$)



Night Sky in Microwave (~1mm)



Night Sky in Microwave ($\sim 1\text{mm}$)

$T_{\text{today}} = 2.725\text{K}$

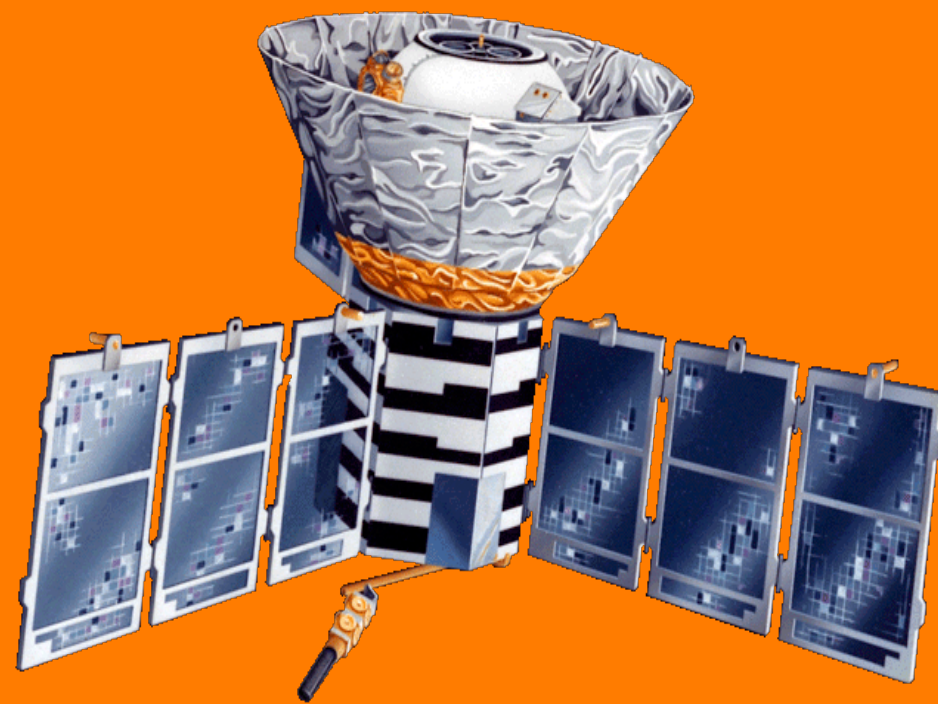

COBE Satellite, 1989-1993

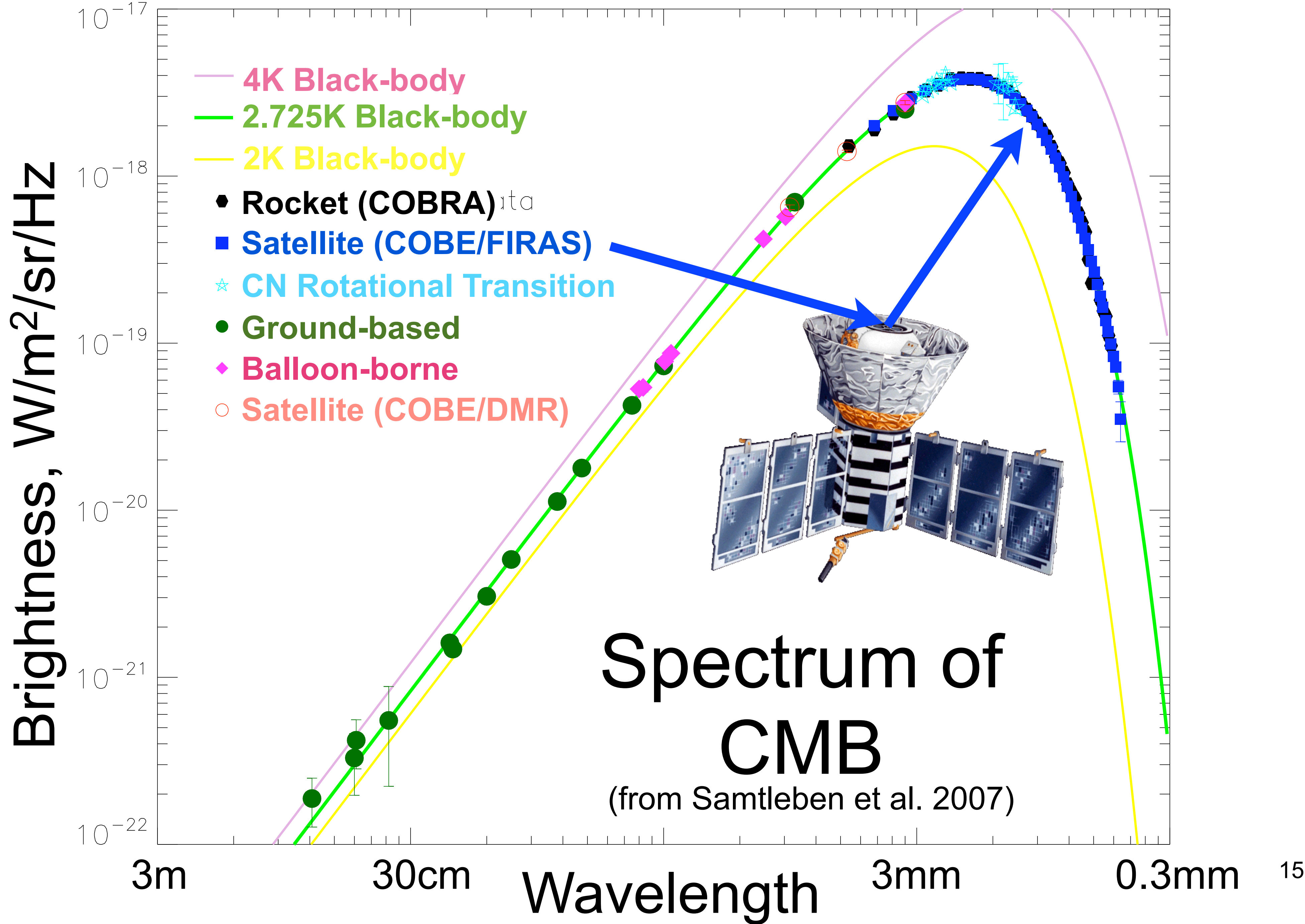

Arno Penzias & Robert Wilson, 1965

A MEASUREMENT OF EXCESS ANTENNA TEMPERATURE AT 4080 Mc/s

Measurements of the effective zenith noise temperature of the 20-foot horn-reflector antenna (Crawford, Hogg, and Hunt 1961) at the Crawford Hill Laboratory, Holmdel, New Jersey, at 4080 Mc/s have yielded a value about 3.5° K higher than expected. This excess temperature is, within the limits of our observations, isotropic, unpolarized, and free from seasonal variations (July, 1964–April, 1965). A possible explanation for the observed excess noise temperature is the one given by Dicke, Peebles, Roll, and Wilkinson (1965) in a companion letter in this issue.

- **Isotropic**
- **Unpolarized**

May 13, 1965
BELL TELEPHONE LABORATORIES, INC
CRAWFORD HILL, HOLMDEL, NEW JERSEY

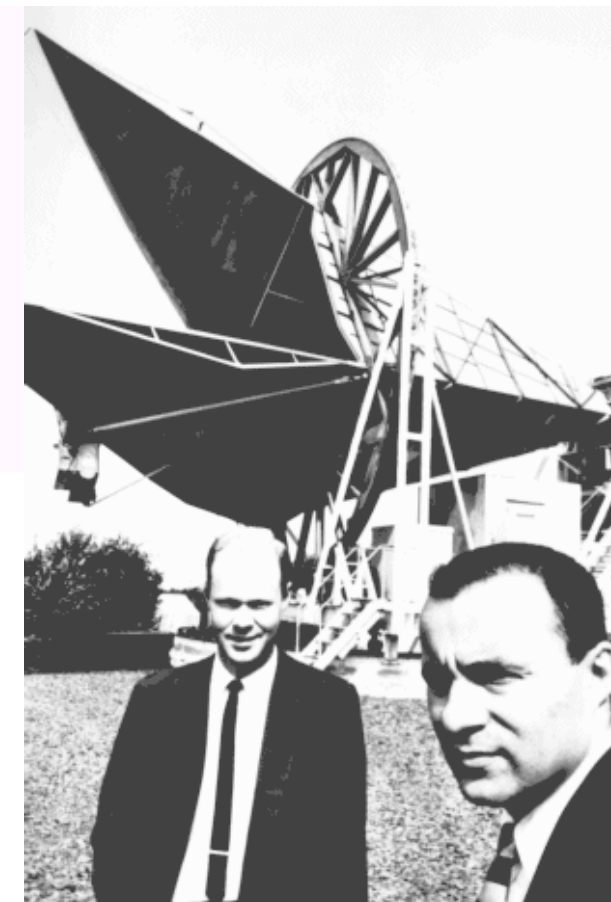

A. A. PENZIAS
R. W. WILSON



The Nobel Prize in Physics 1978

"for his basic inventions and discoveries in the area of low-temperature physics"

“For their discovery of cosmic microwave background radiation”

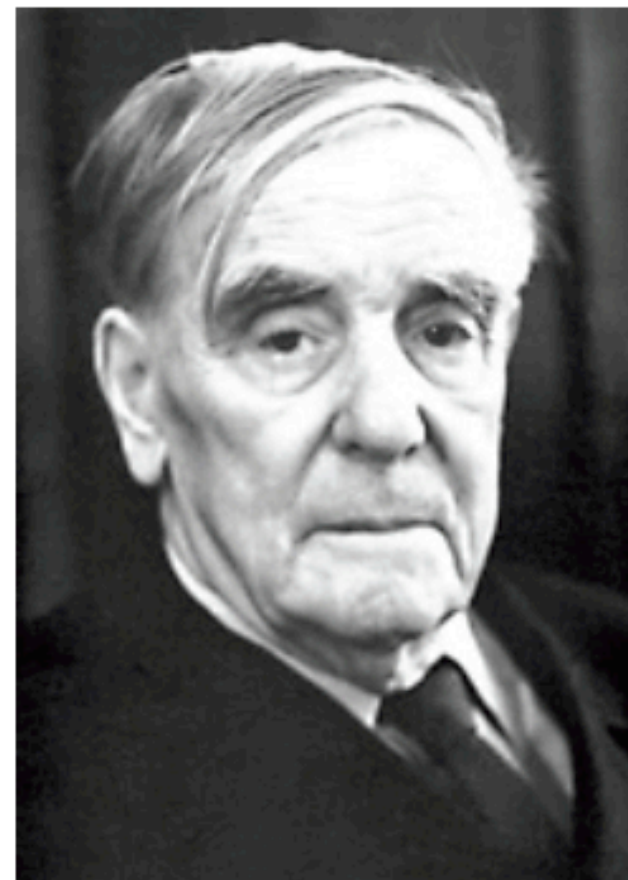

Pyotr Leonidovich Kapitsa

🕒 1/2 of the prize

USSR

Academy of Sciences
Moscow, USSR

b. 1894
d. 1984



Arno Allan Penzias

🕒 1/4 of the prize

USA

Bell Laboratories
Holmdel, NJ, USA

b. 1933
(in Munich, Germany)



Robert Woodrow Wilson

🕒 1/4 of the prize

USA

Bell Laboratories
Holmdel, NJ, USA

b. 1936



COBE/DMR, 1992

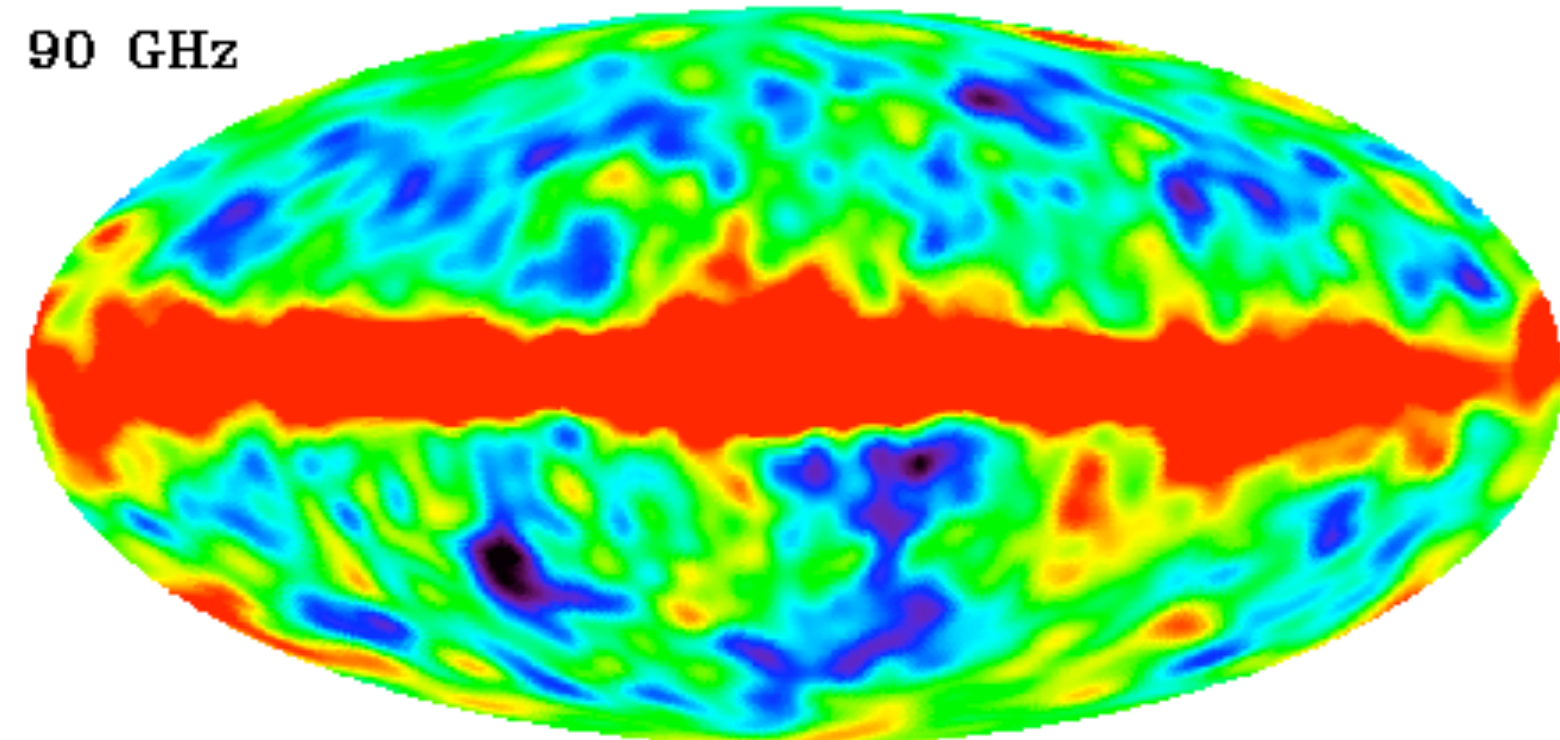
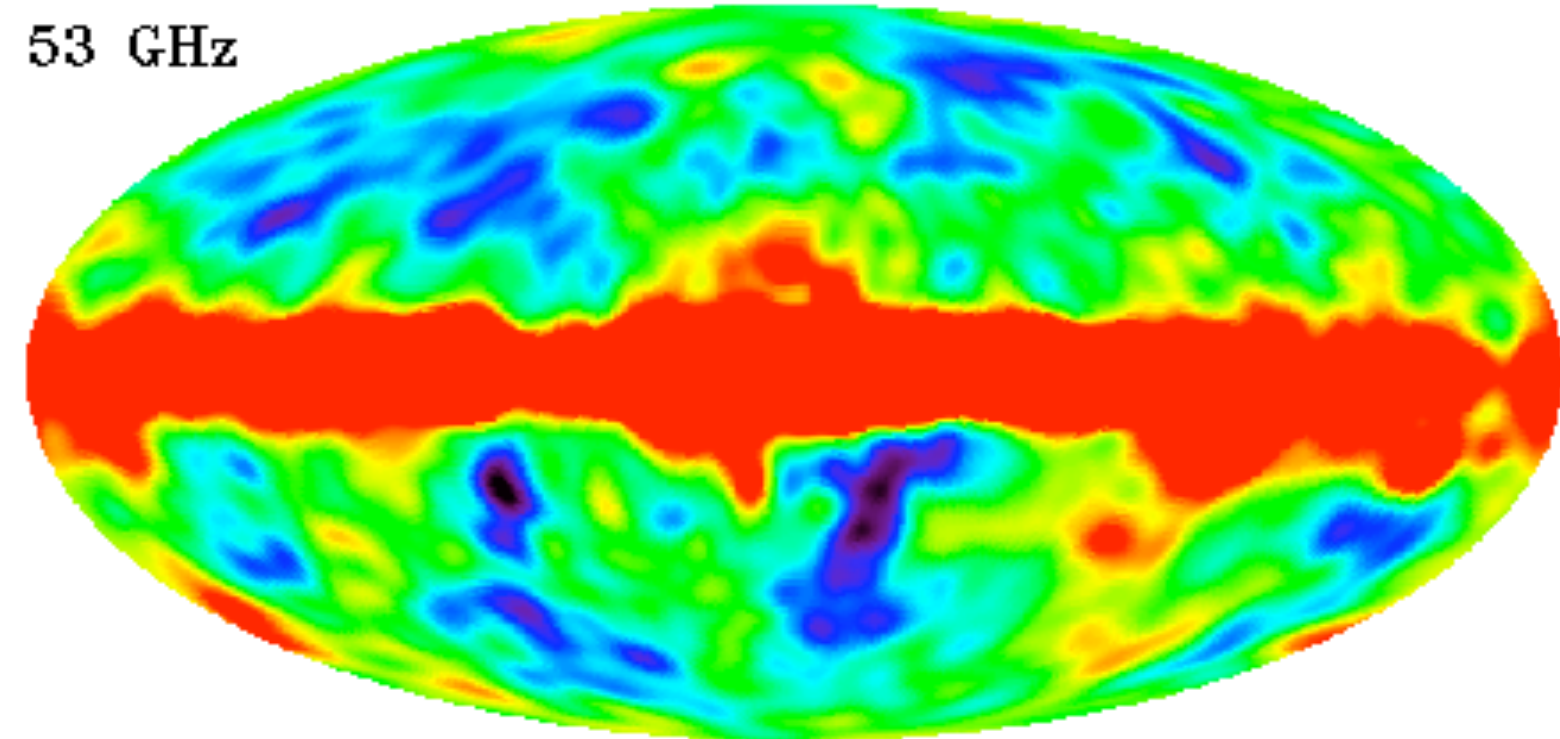
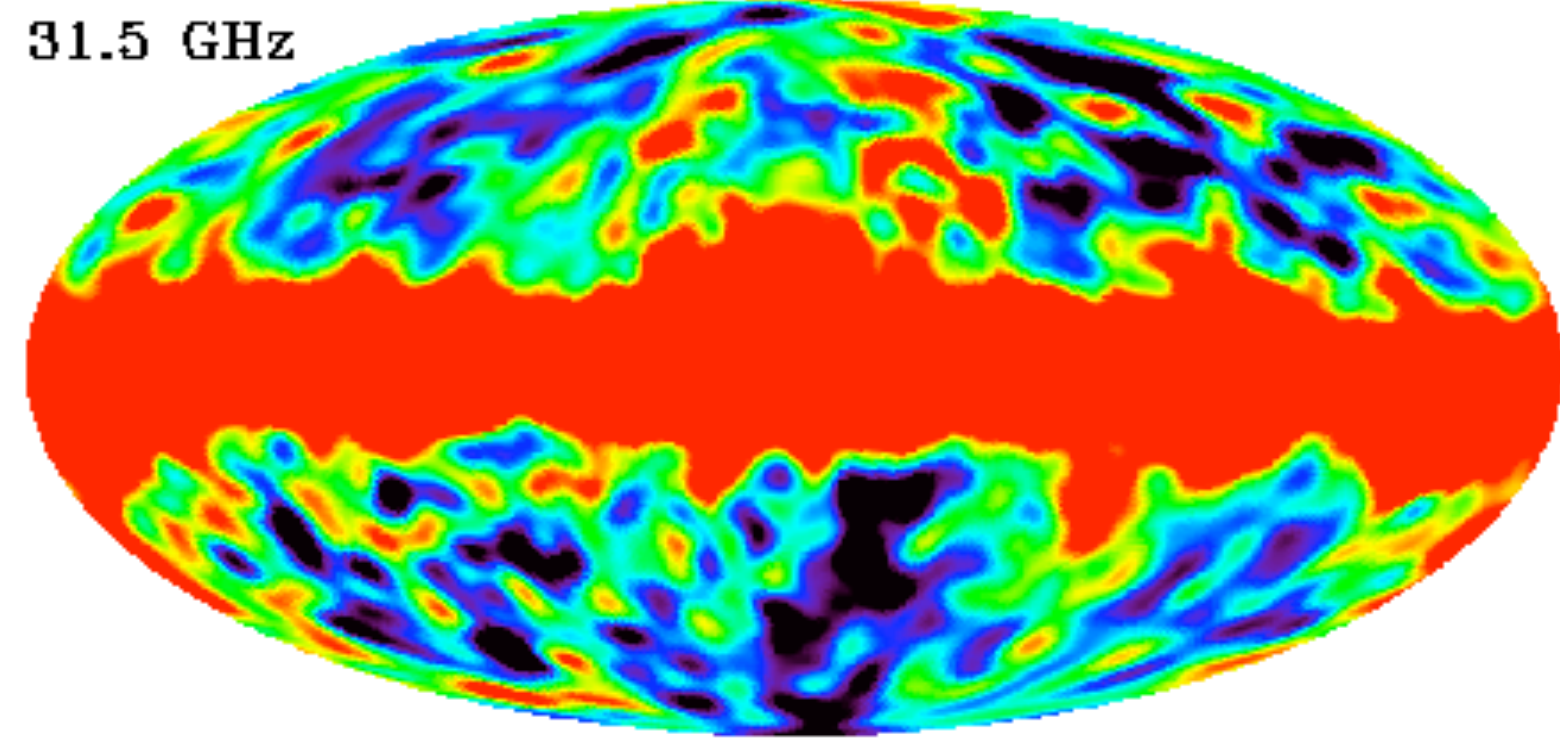

-100 μK  +100 μK



• **Isotropic?**

• **CMB is *anisotropic!* (at the 1/100,000 level)**



The Nobel Prize in Physics 2006

“For their discovery of the **blackbody form** and **anisotropy** of the cosmic microwave background radiation”

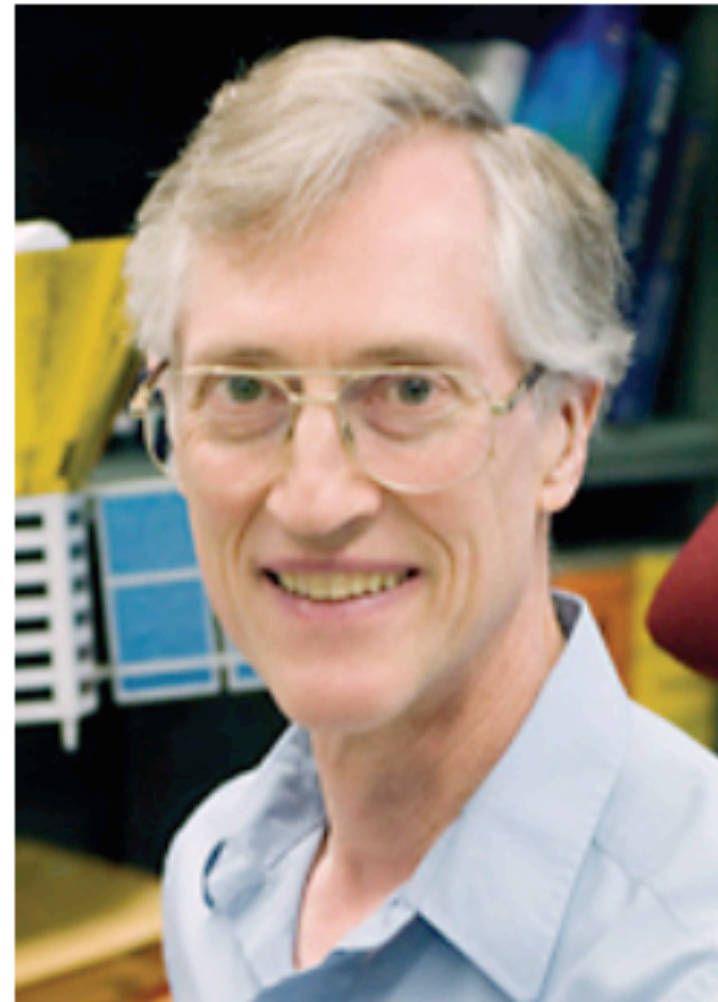

Photo: NASA

John C. Mather

🏆 1/2 of the prize

USA

NASA Goddard Space
Flight Center
Greenbelt, MD, USA

b. 1946

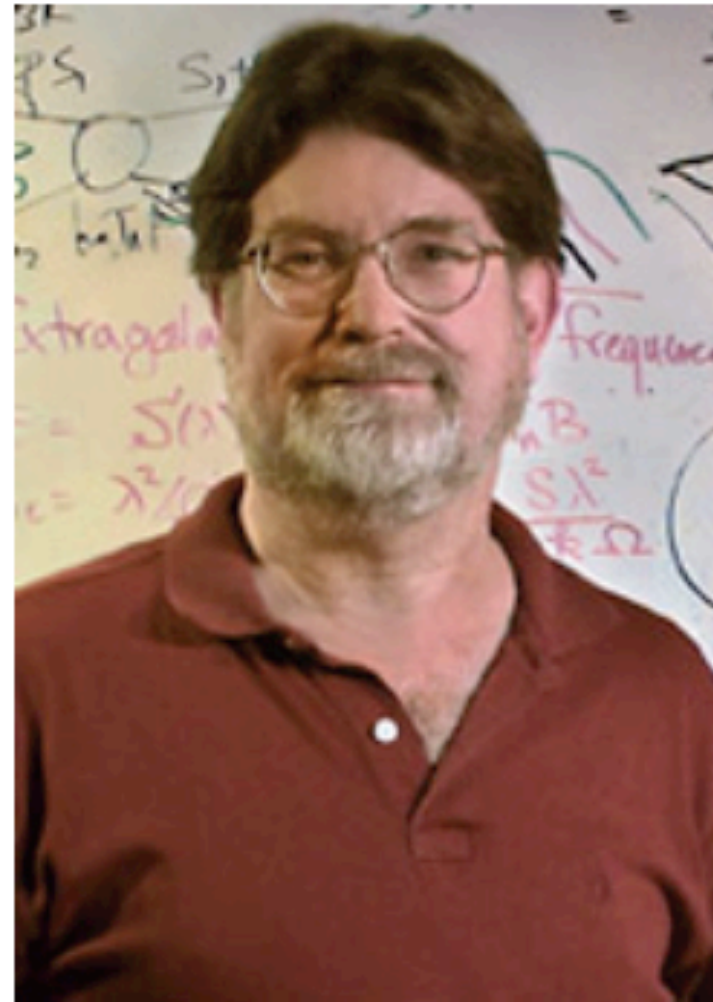

Photo: R. Kaltschmidt/LBNL

George F. Smoot

🏆 1/2 of the prize

USA

University of California
Berkeley, CA, USA

b. 1945

CMB: The Farthest and Oldest Light That We Can Ever Hope To Observe Directly

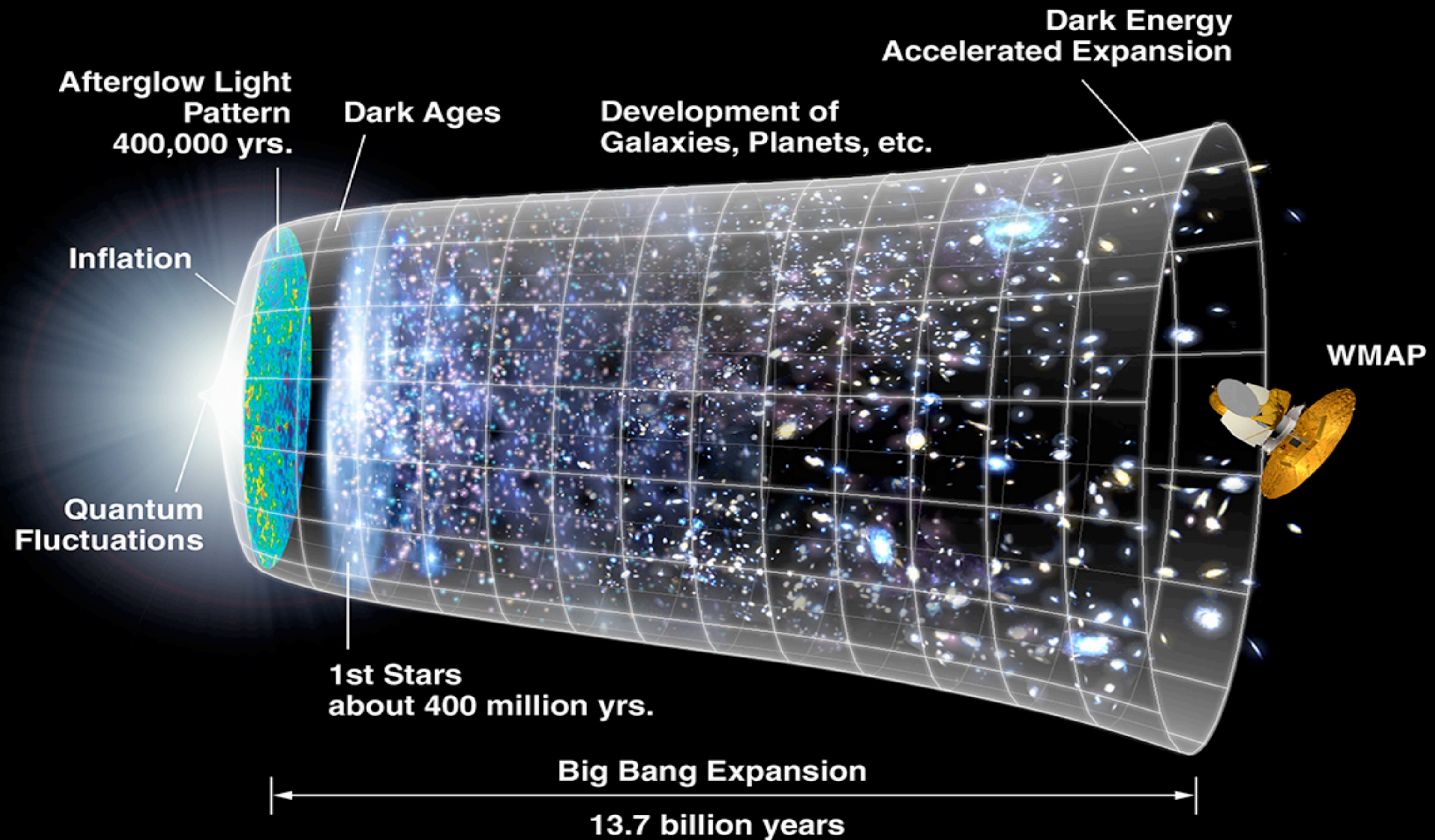

- When the Universe was 3000K (~380,000 years after the Big Bang), electrons and protons were combined to form neutral hydrogen.

WMAP at Lagrange 2 (L2) Point

June 2001:
WMAP launched!

February 2003:
The first-year data
release

March 2006:
The three-year data
release

**March 2008:
The five-year
data release**

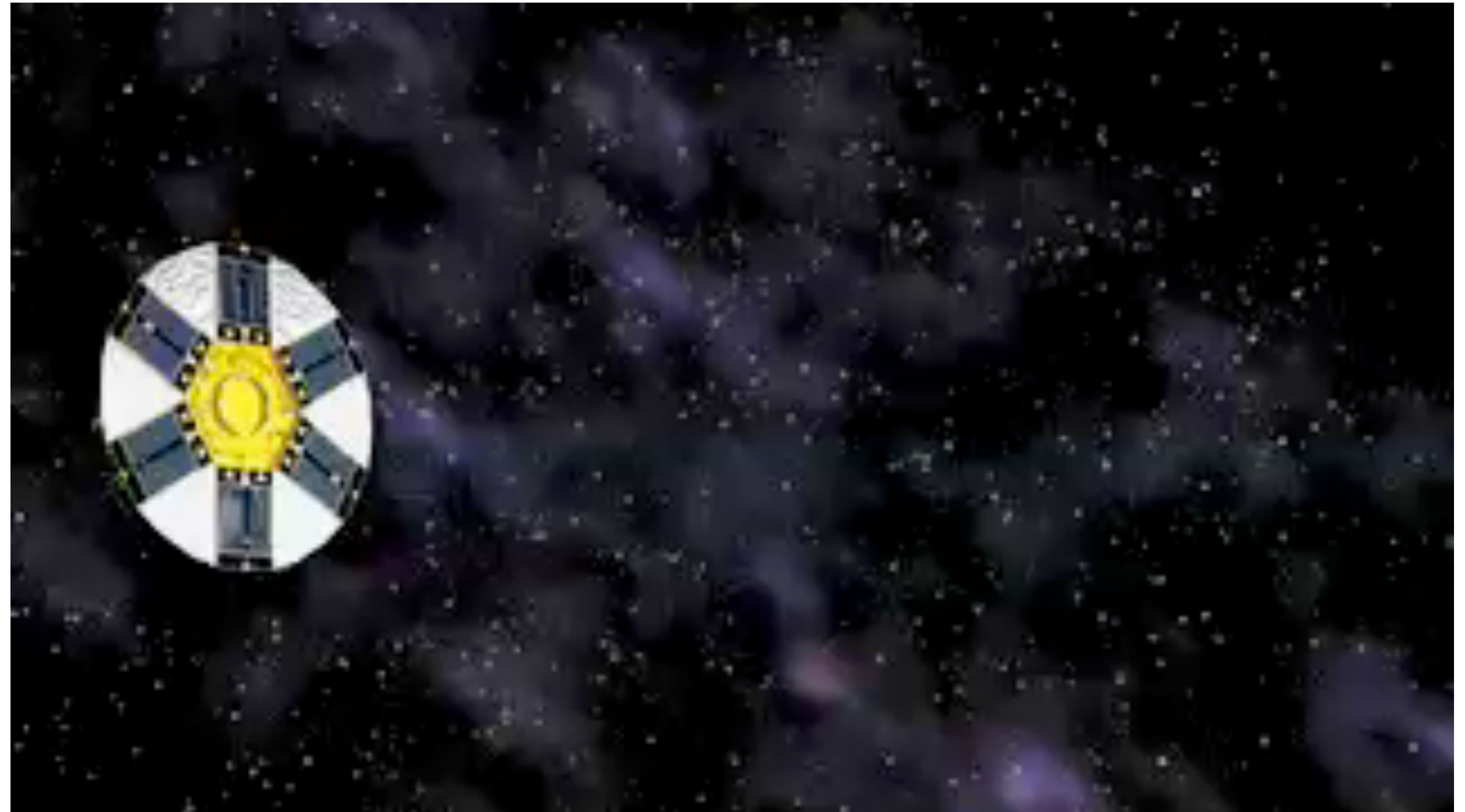

- L2 is a million miles from Earth
- WMAP leaves Earth, Moon, and Sun behind it to avoid radiation from them

WMAP Spacecraft

Radiative Cooling: No Cryogenic System

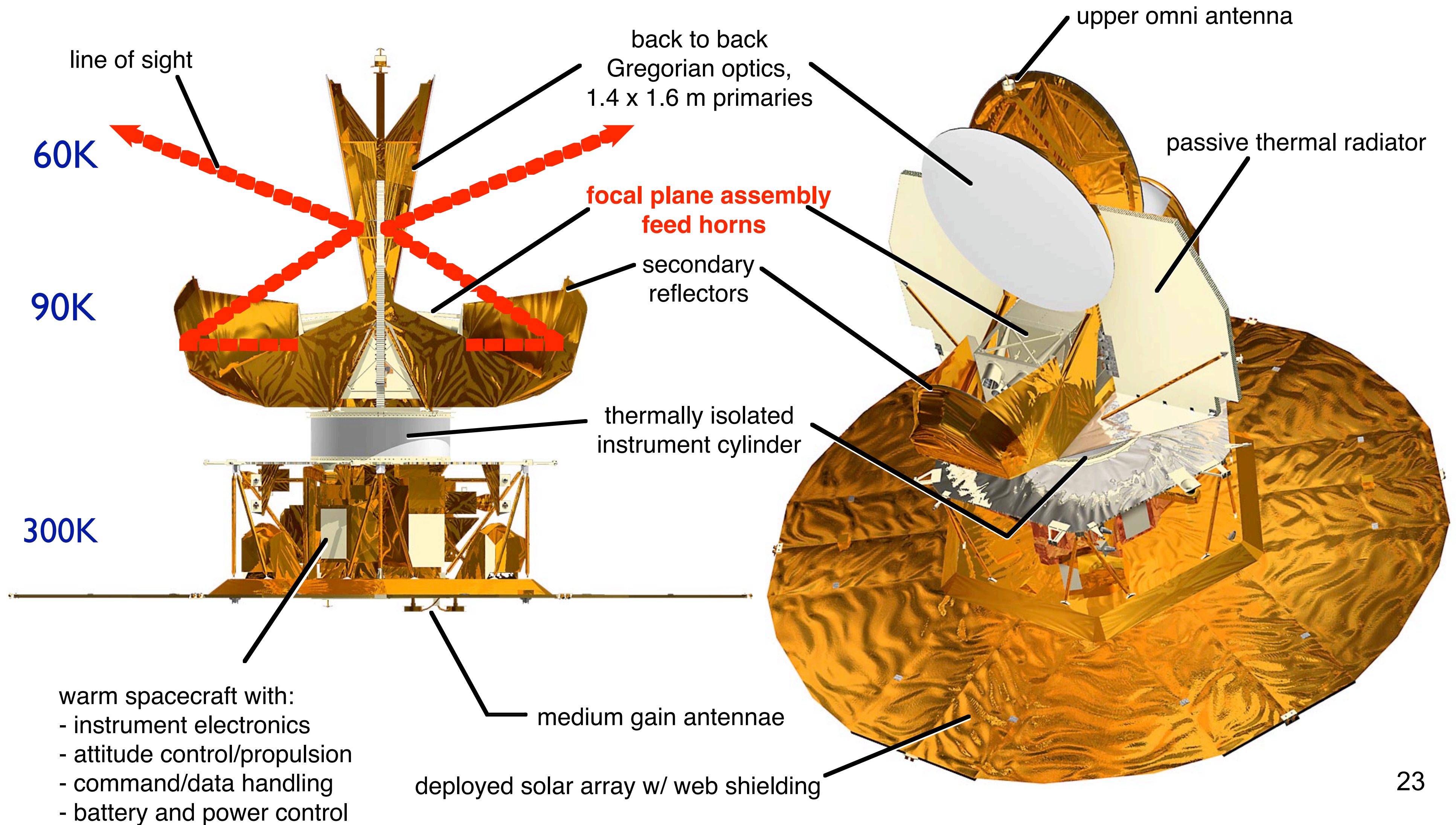

COBE to WMAP (x35 better resolution)



COBE
1989

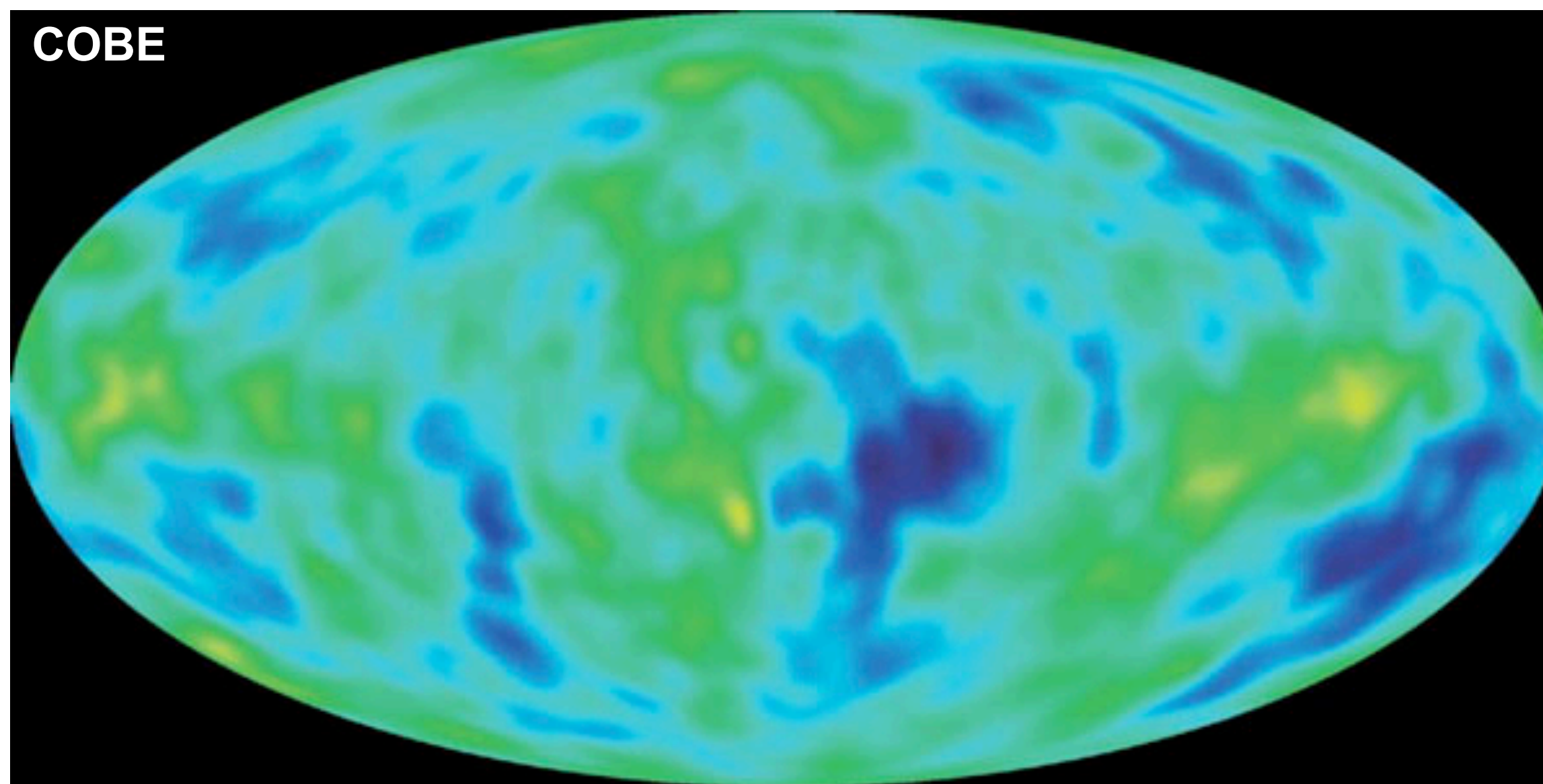

WMAP

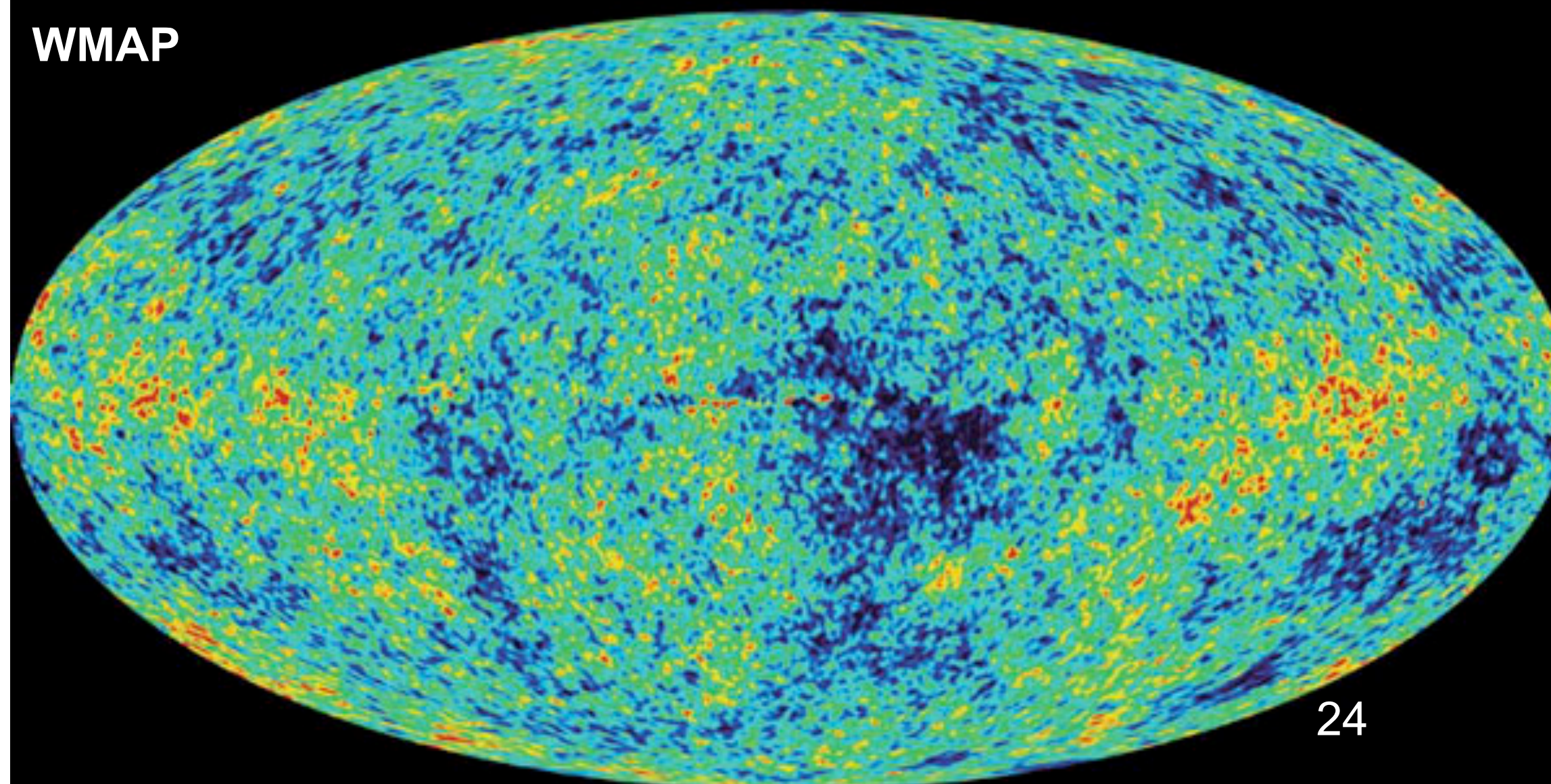

WMAP
2001



WMAP First Year Science Team



- WMAP is currently planned to complete 9 years of full-sky survey, ending its mission in ~2010–2011.

WMAP First Year Science Team



Principal Investigator:
Charles L. Bennett



- WMAP is currently planned to complete 9 years of full-sky survey, ending its mission in ~2010–2011.

WMAP 5-Year Science Team

- C.L. Bennett
- G. Hinshaw
- N. Jarosik
- S.S. Meyer
- L. Page
- D.N. Spergel
- E.L. Wright
- M.R. Greason
- M. Halpern
- R.S. Hill
- A. Kogut
- M. Limon
- N. Odegard
- G.S. Tucker
- J. L. Weiland
- E. Wollack
- J. Dunkley
- B. Gold
- E. Komatsu
- D. Larson
- M.R.olta

Special
Thanks to
WMAP
Graduates!

- C. Barnes
- R. Bean
- O. Dore
- H.V. Peiris
- L. Verde

WMAP 5-Year Papers

- **Hinshaw et al.**, “*Data Processing, Sky Maps, and Basic Results*” [ApJS, 180, 225 \(2009\)](#)
- **Hill et al.**, “*Beam Maps and Window Functions*” [ApJS, 180, 246](#)
- **Gold et al.**, “*Galactic Foreground Emission*” [ApJS, 180, 265](#)
- **Wright et al.**, “*Source Catalogue*” [ApJS, 180, 283](#)
- **Nolta et al.**, “*Angular Power Spectra*” [ApJS, 180, 296](#)
- **Dunkley et al.**, “*Likelihoods and Parameters from the WMAP data*” [ApJS, 180, 306](#)
- **Komatsu et al.**, “*Cosmological Interpretation*” [ApJS, 180, 330](#)

Temperature Anisotropy (Unpolarized)

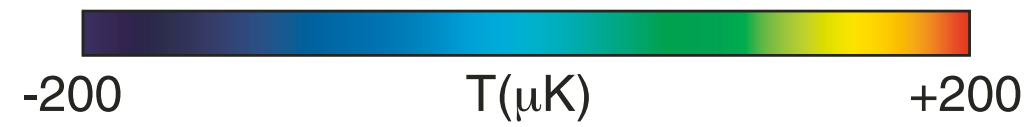
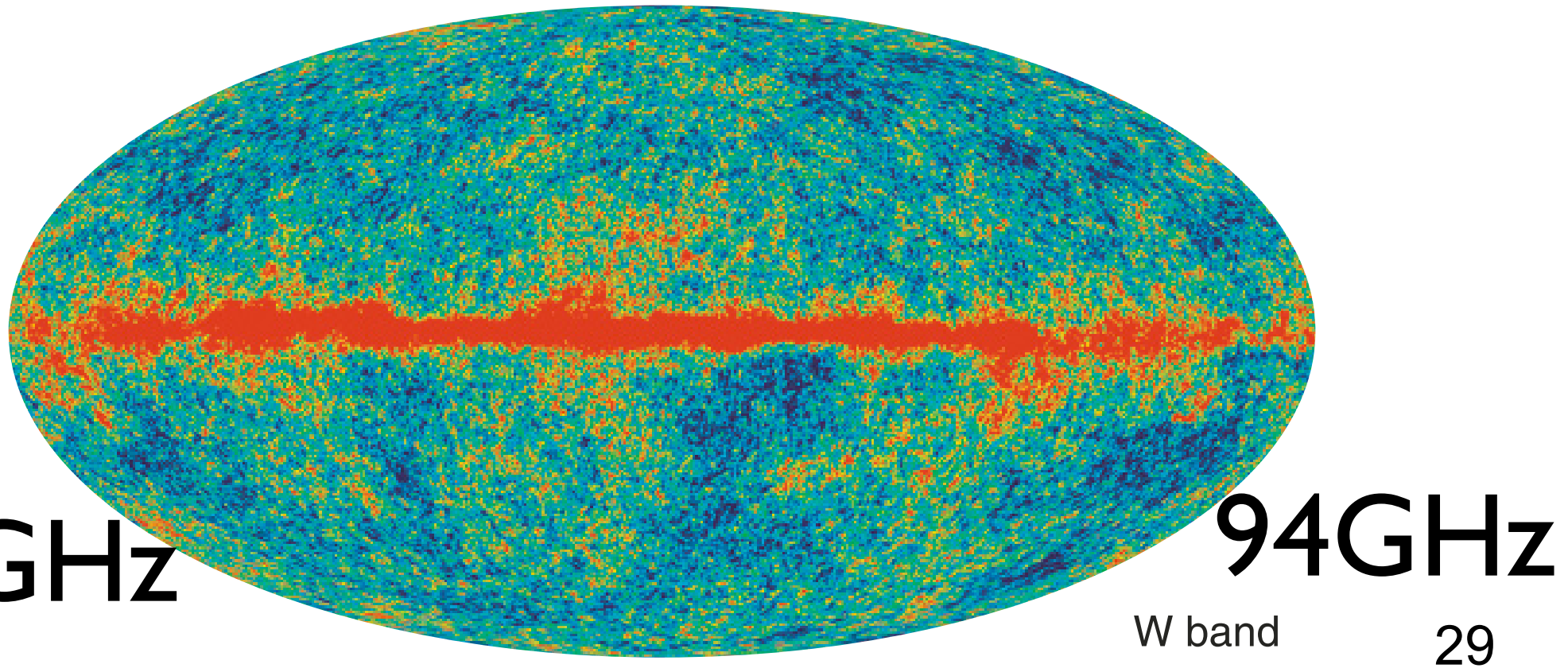
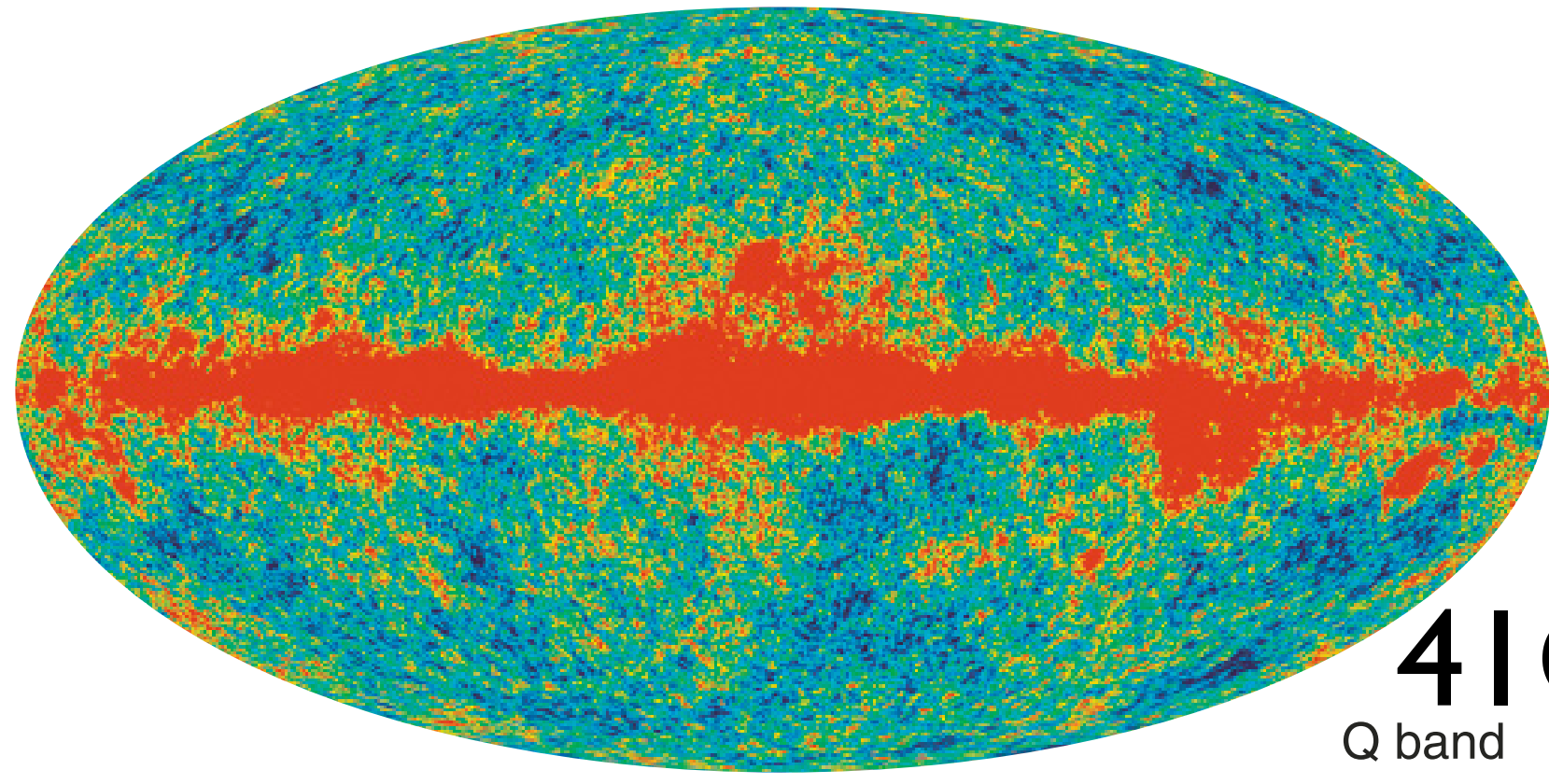
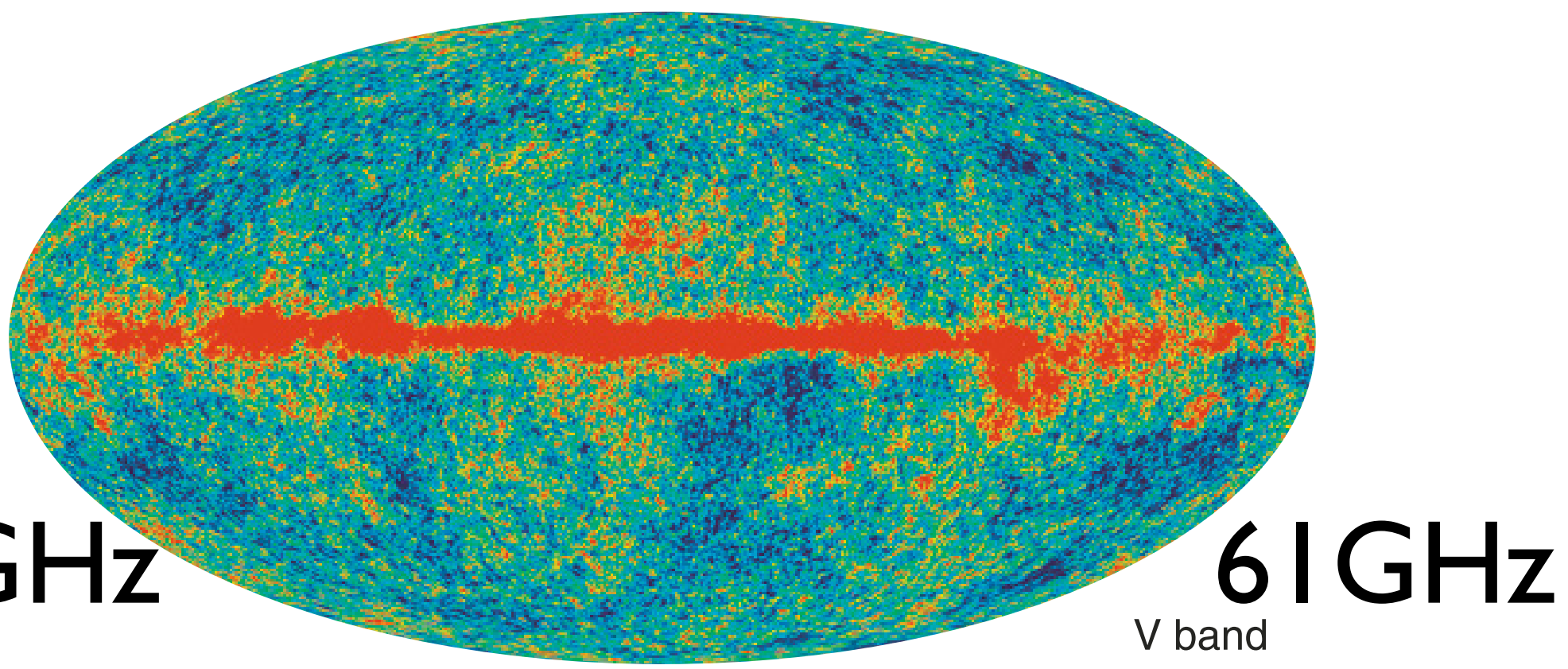
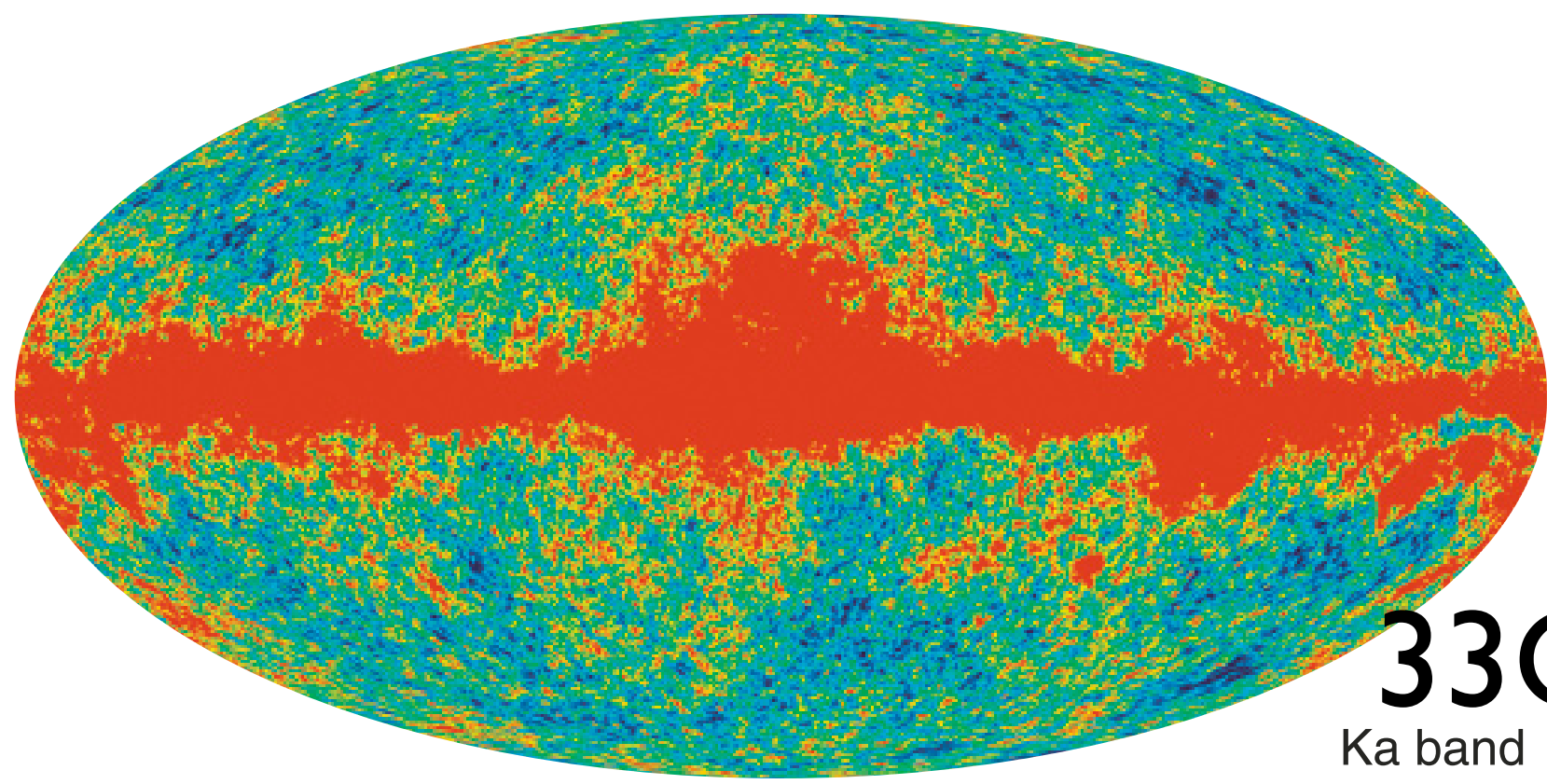
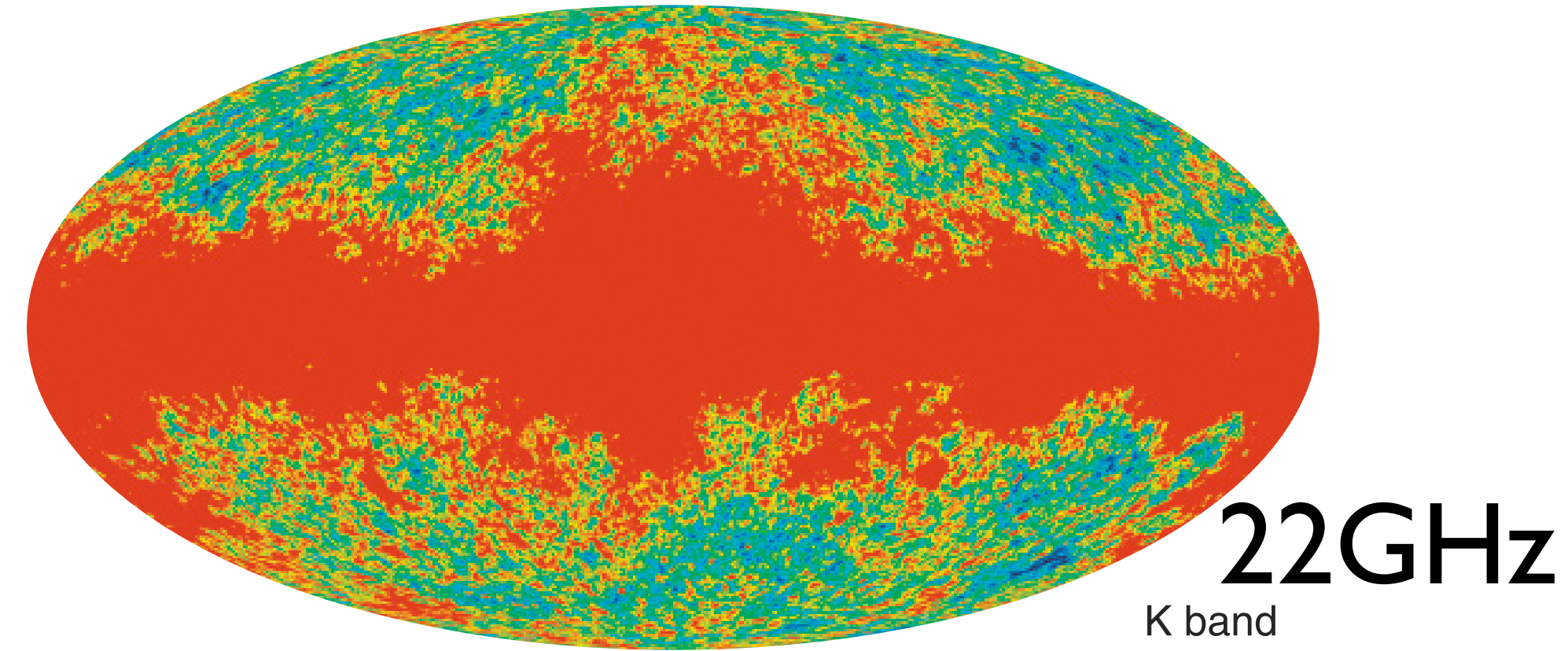

Galaxy-cleaned Map

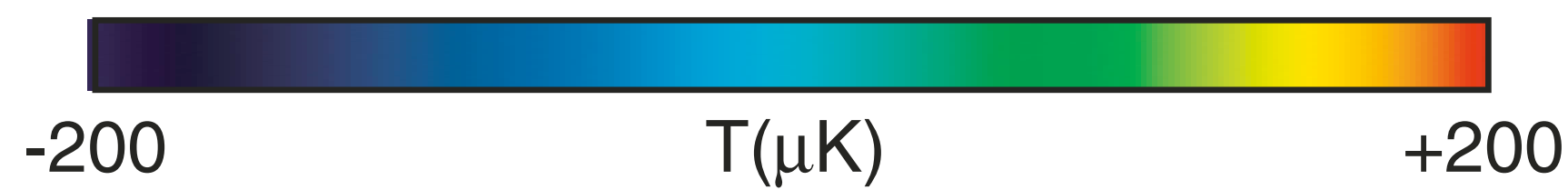
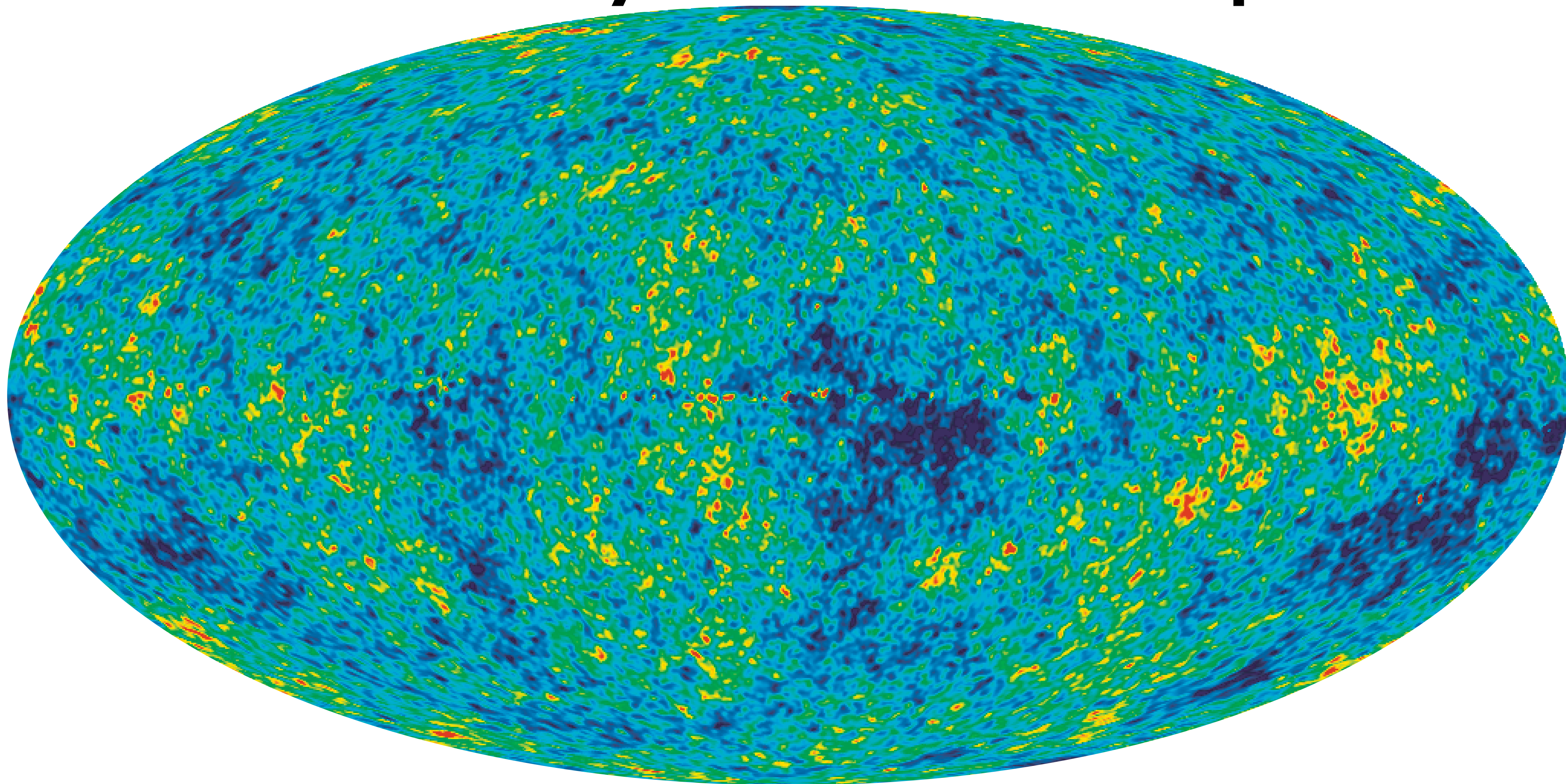

WMAP 5-year

Analysis: 2-point Correlation

- $C(\theta) = (1/4\pi) \sum (2l+1) C_l P_l(\cos\theta)$
- How are temperatures on two points on the sky, separated by θ , are correlated?
- **“Power Spectrum,”** C_l
 - How much fluctuation power do we have at a given angular scale?
 - $l \sim 180 \text{ degrees} / \theta$

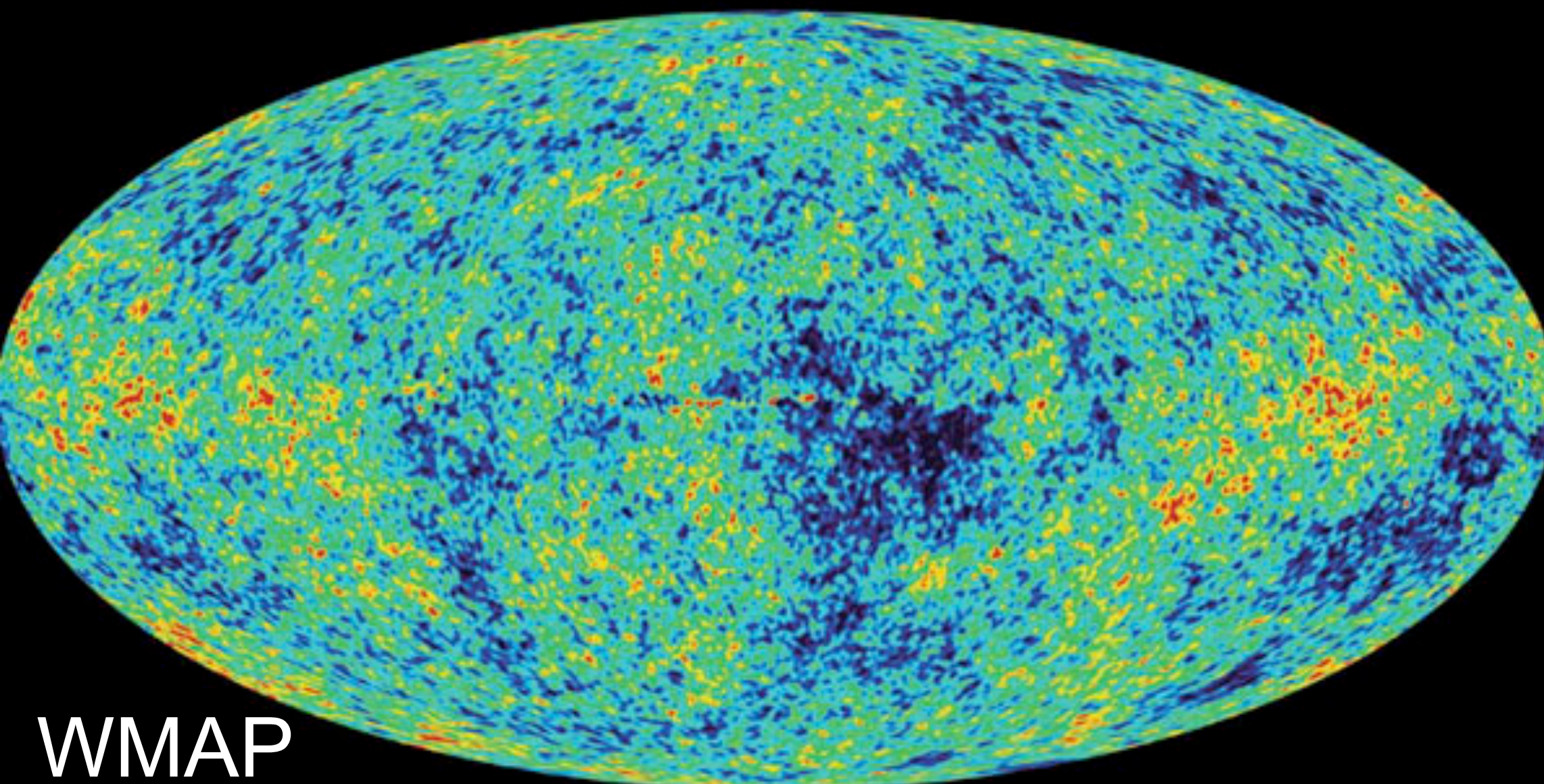
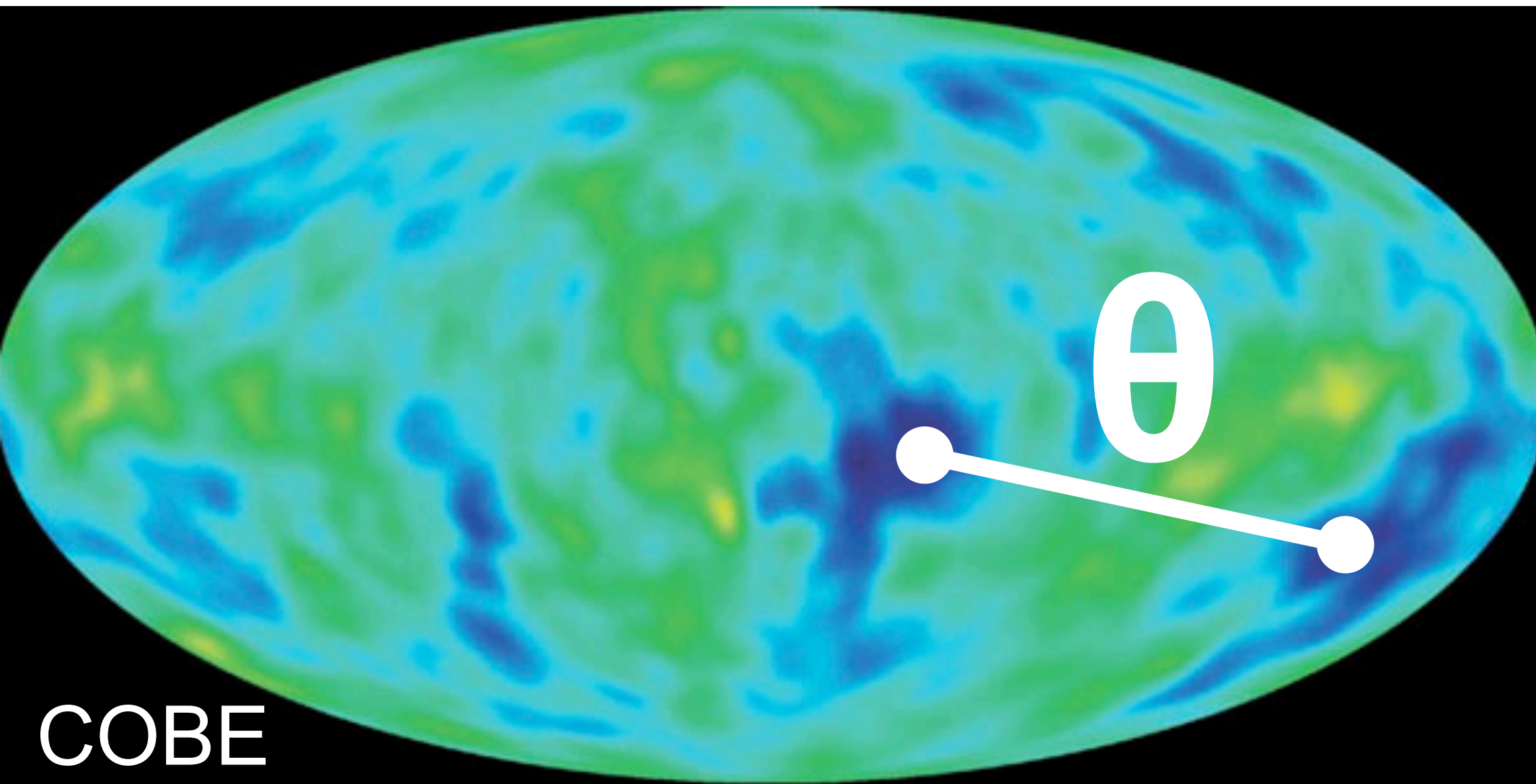

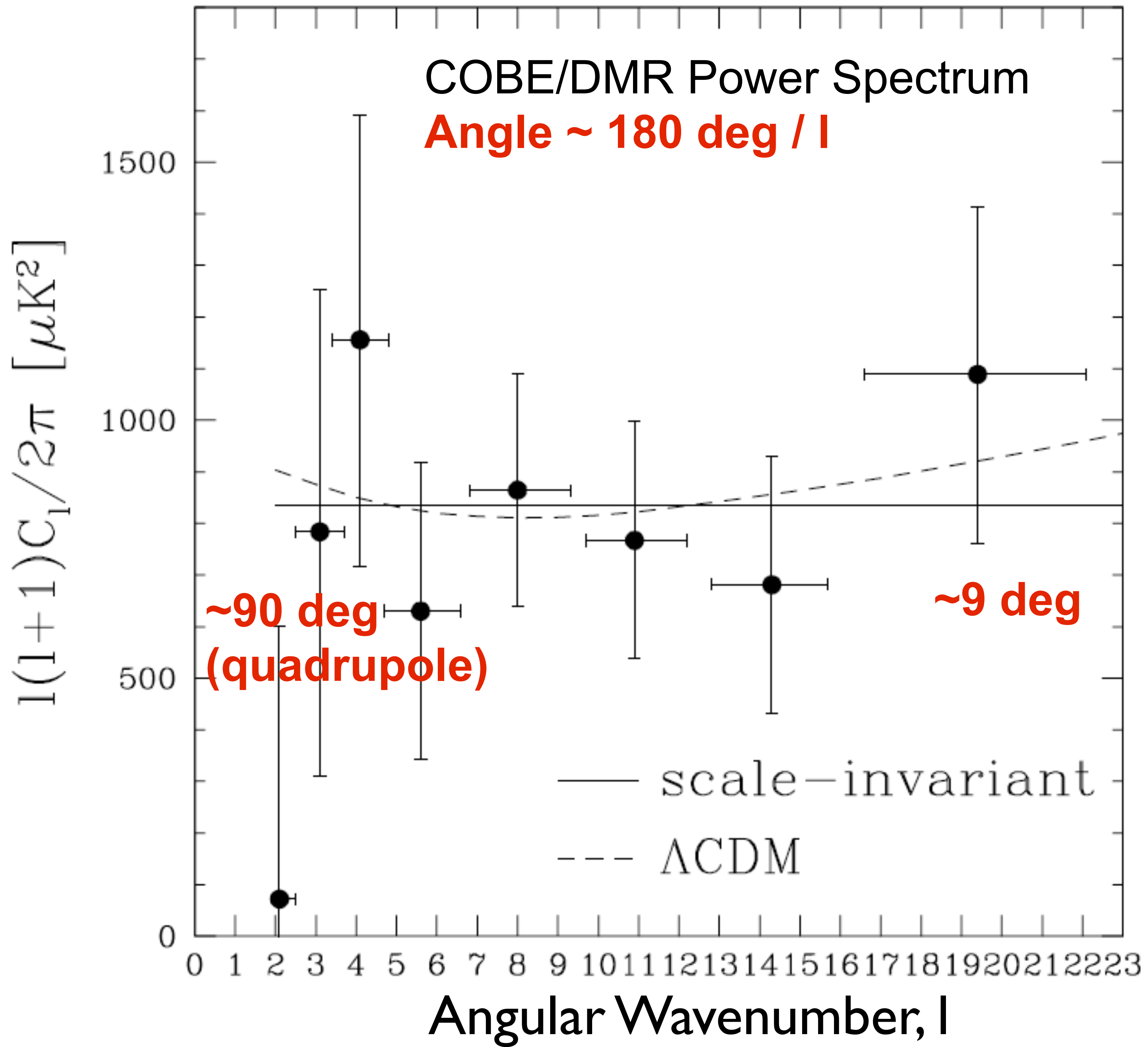

COBE To WMAP

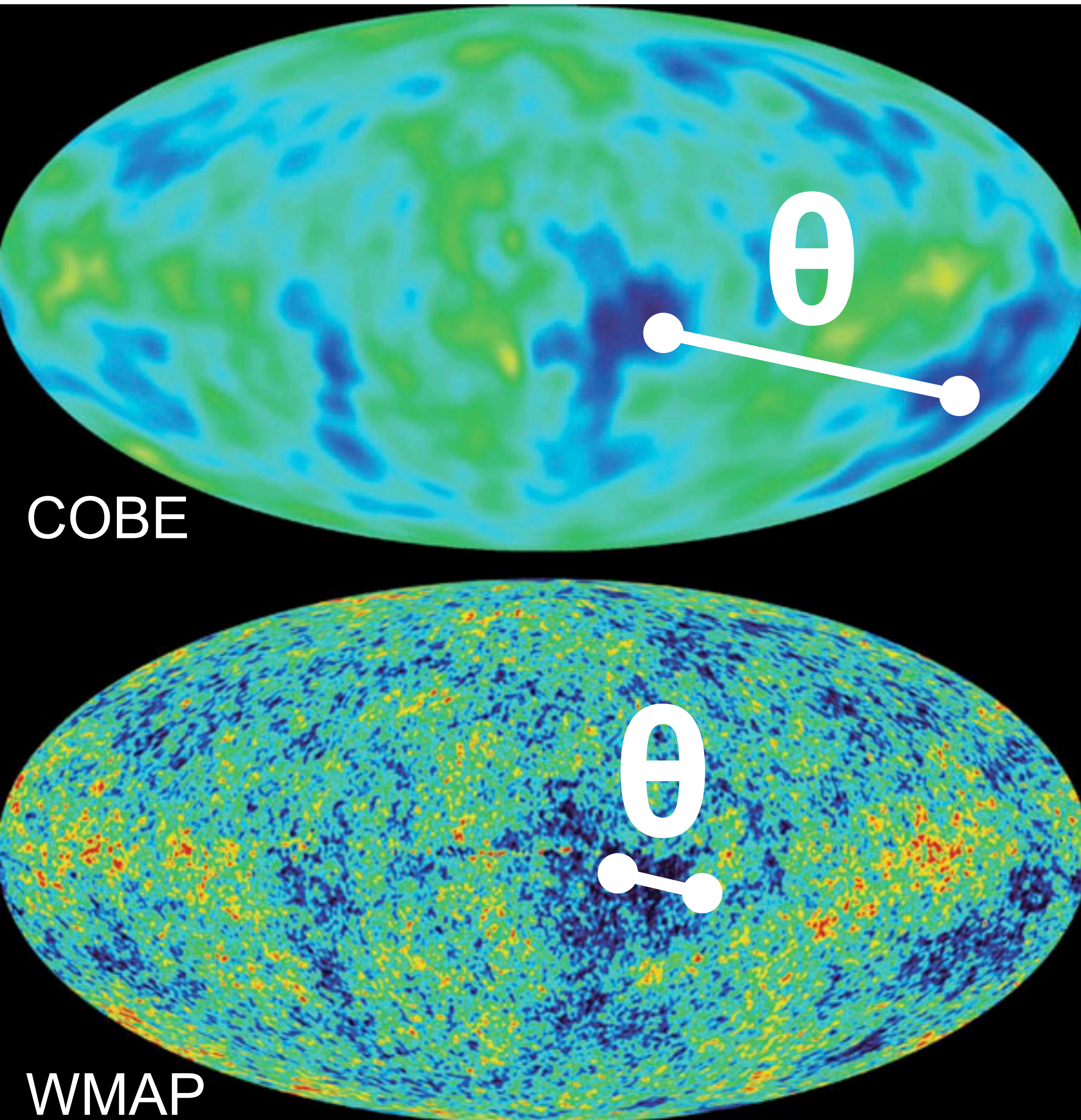

- COBE is unable to resolve the structures below ~ 7 degrees
- WMAP's resolving power is 35 times better than COBE.
- What did WMAP see?

WMAP Power Spectrum

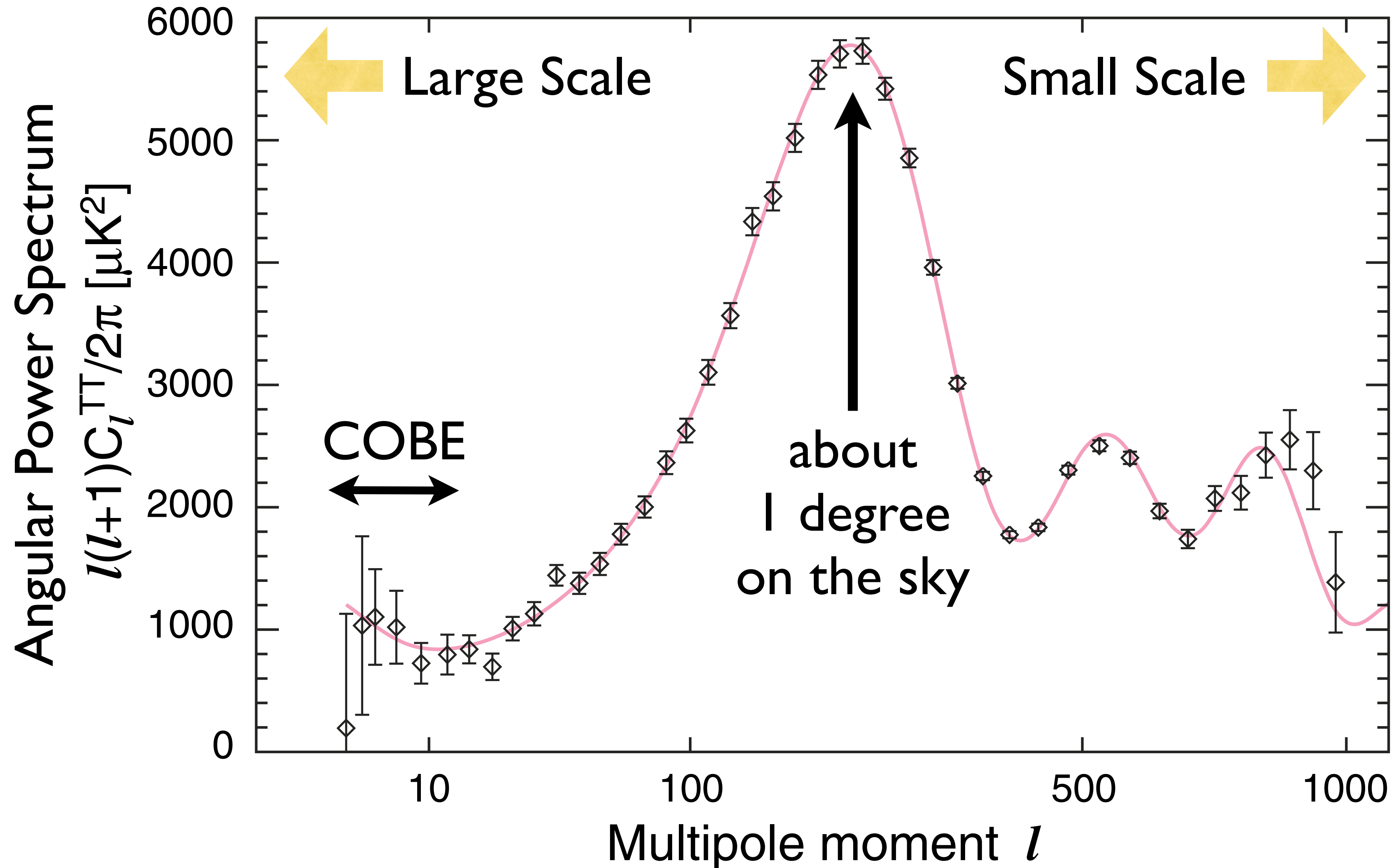

The Cosmic Sound Wave

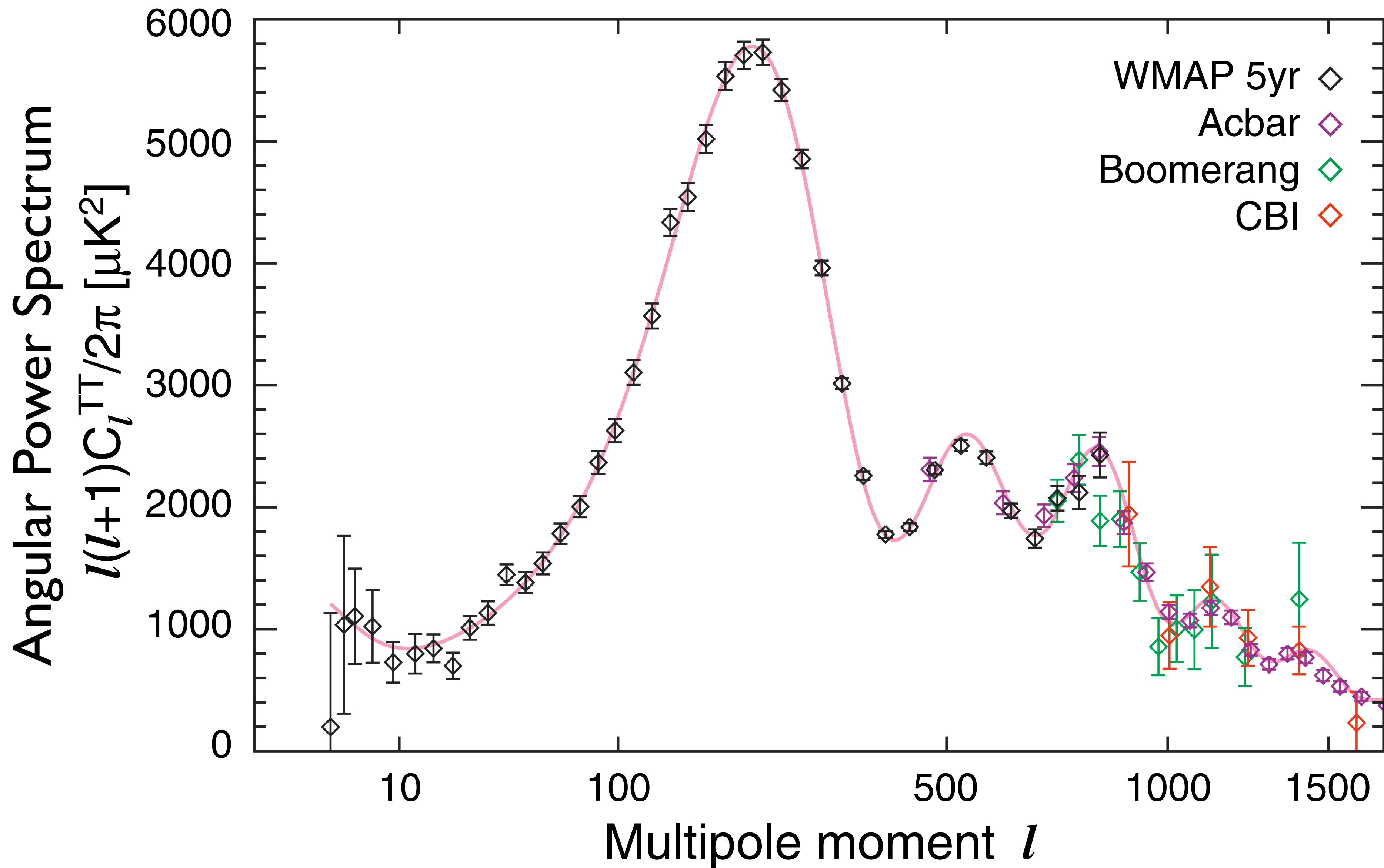

The Cosmic Sound Wave

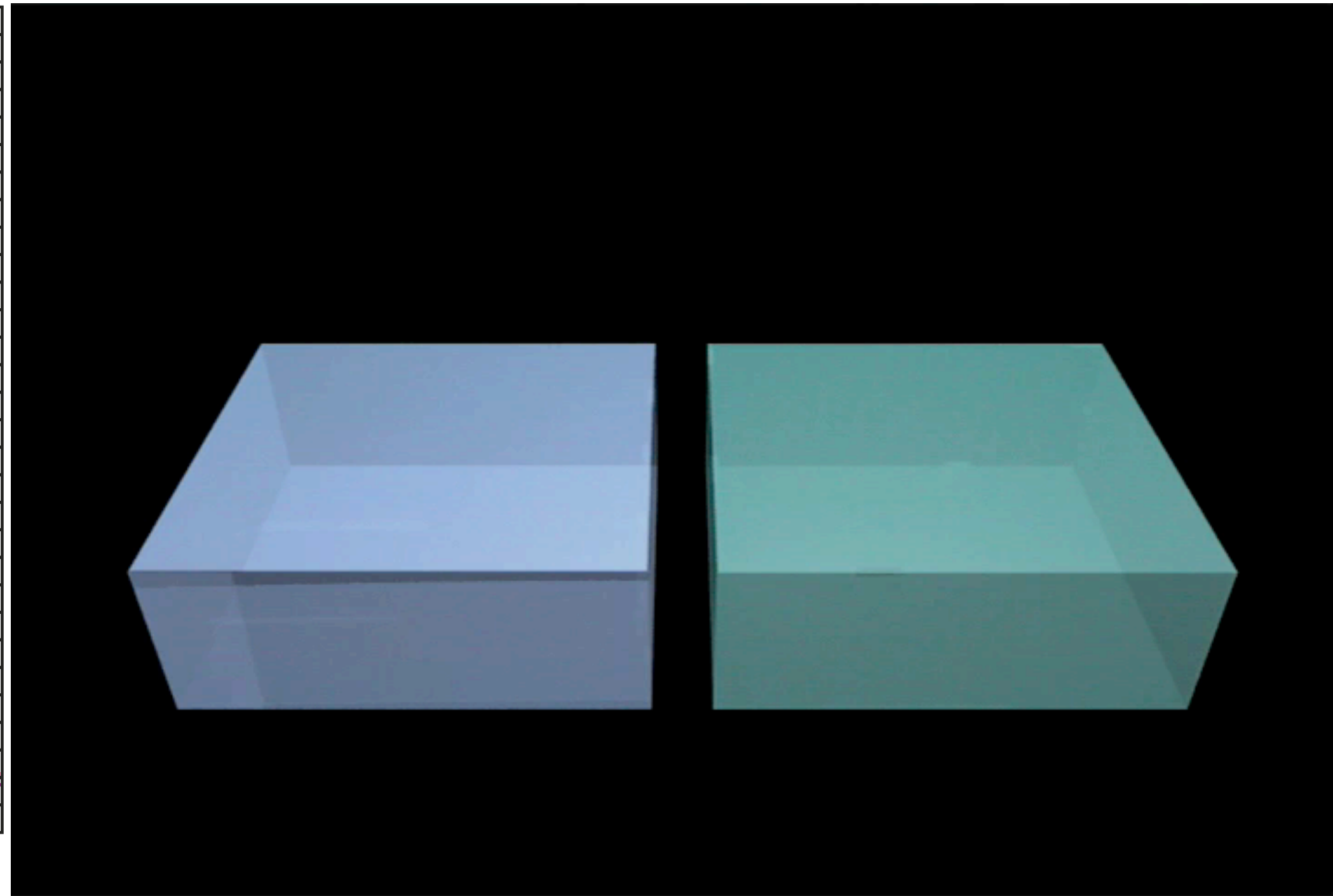
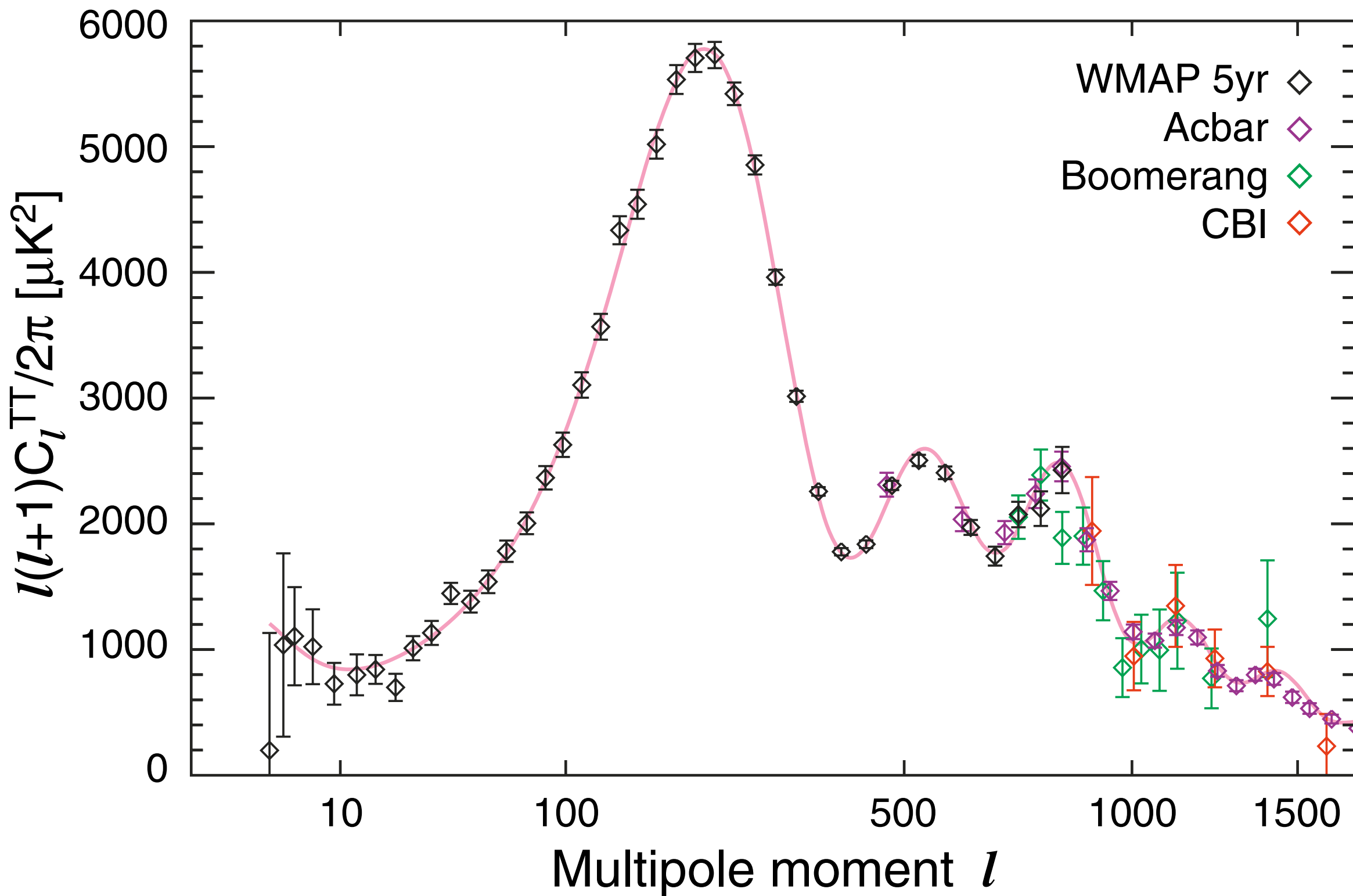

- *“The Universe as a Waterzooi”*
- *Main Ingredients: protons, helium nuclei, electrons, photons*
- We measure the composition of the Universe by analyzing the wave form of the cosmic sound waves.

CMB to Baryon & Dark Matter

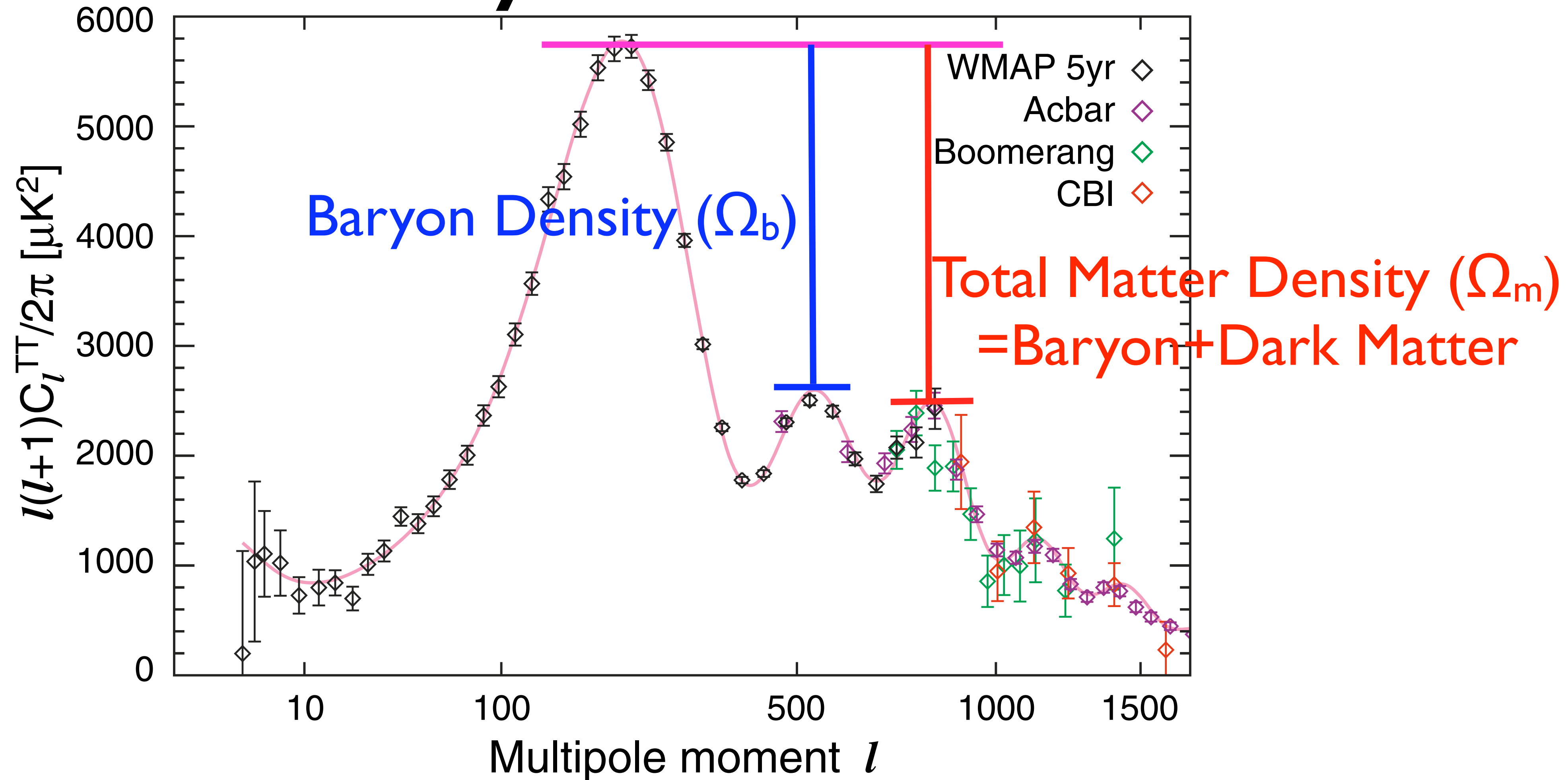

- 1-to-2: baryon-to-photon ratio
- 1-to-3: matter-to-radiation ratio

Determining Baryon Density From C_l

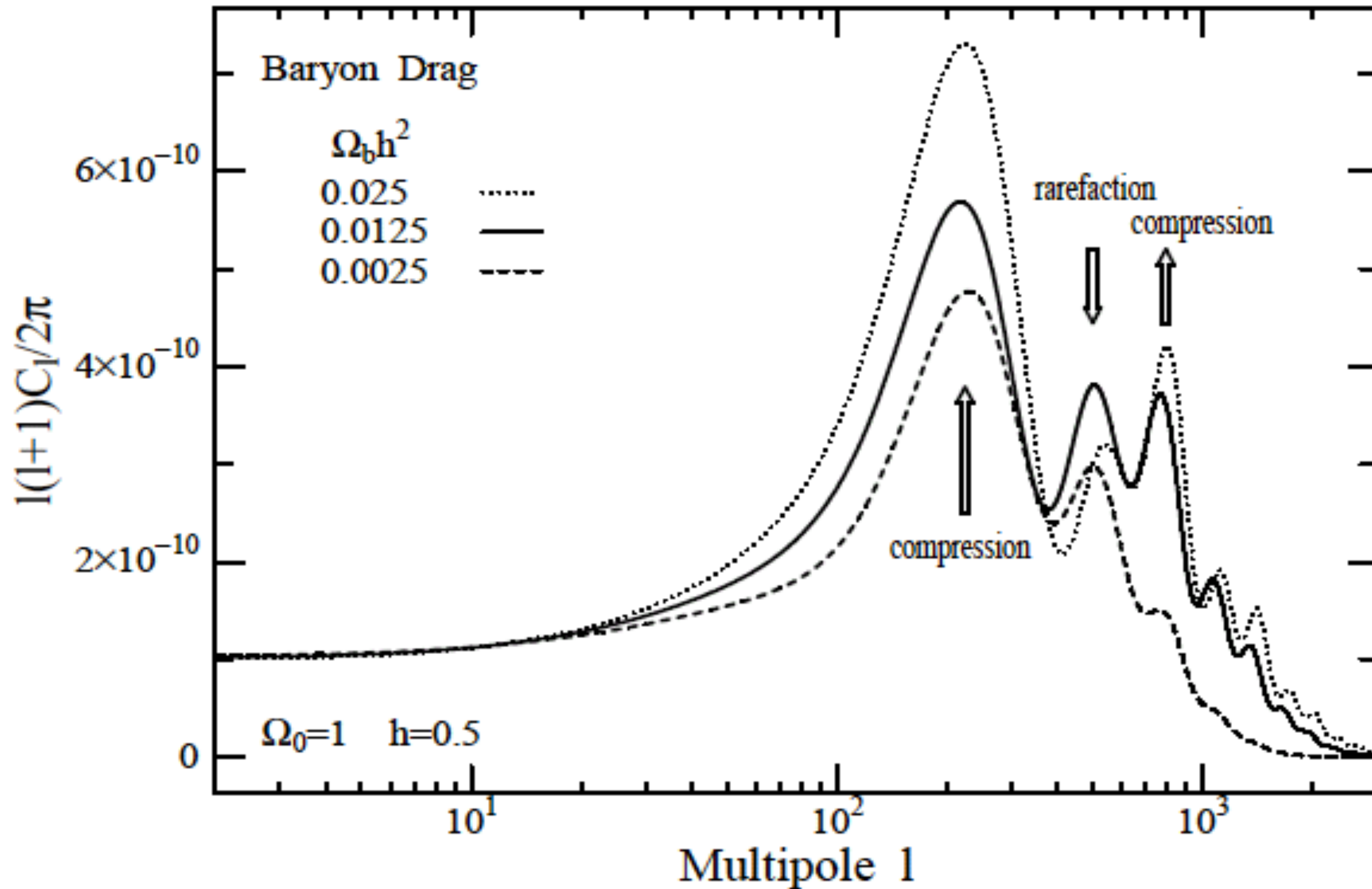

Determining Dark Matter Density From C_l

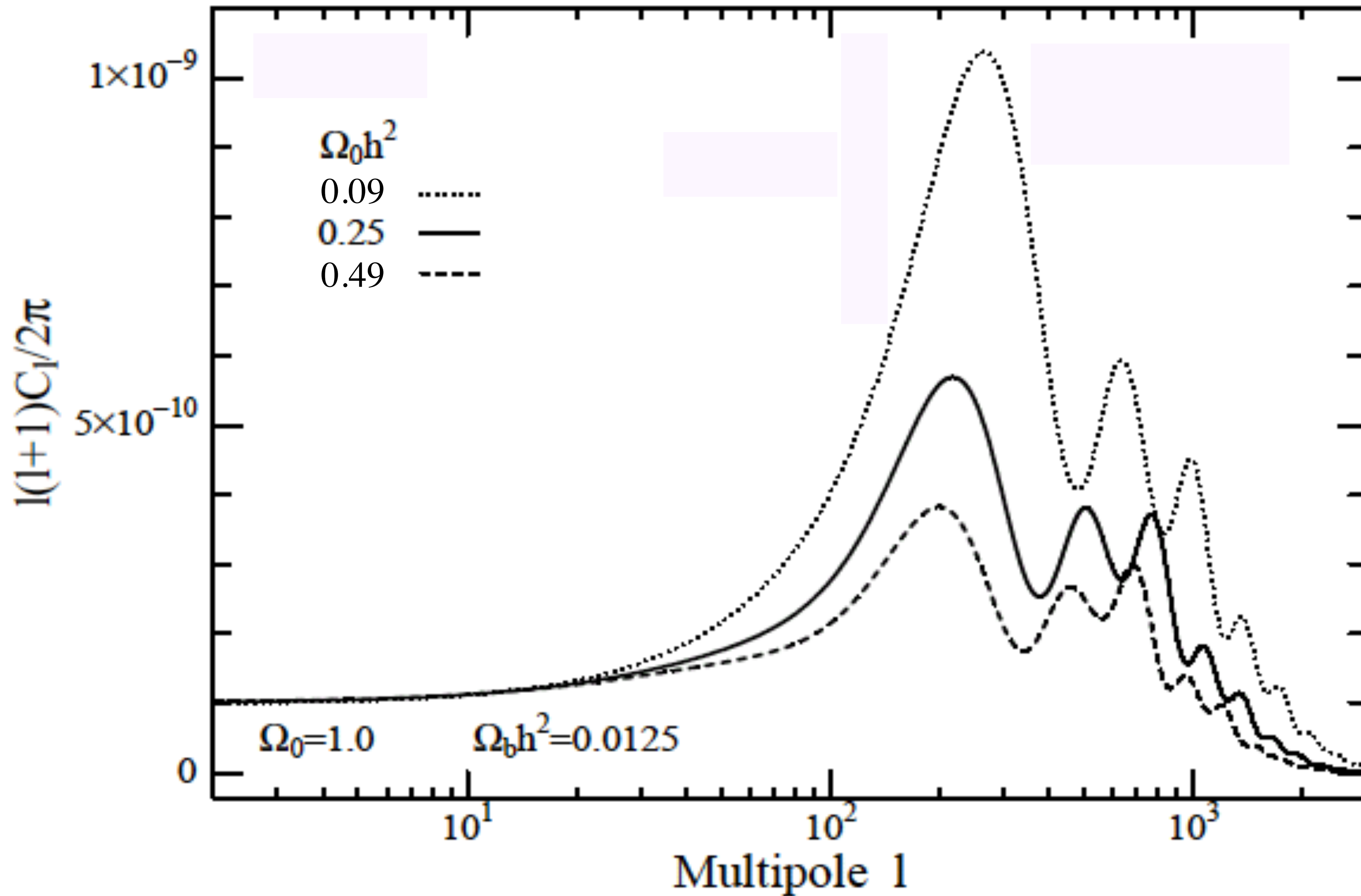

Composition of the Universe

Cosmic Pie Chart “ Λ CDM” Model

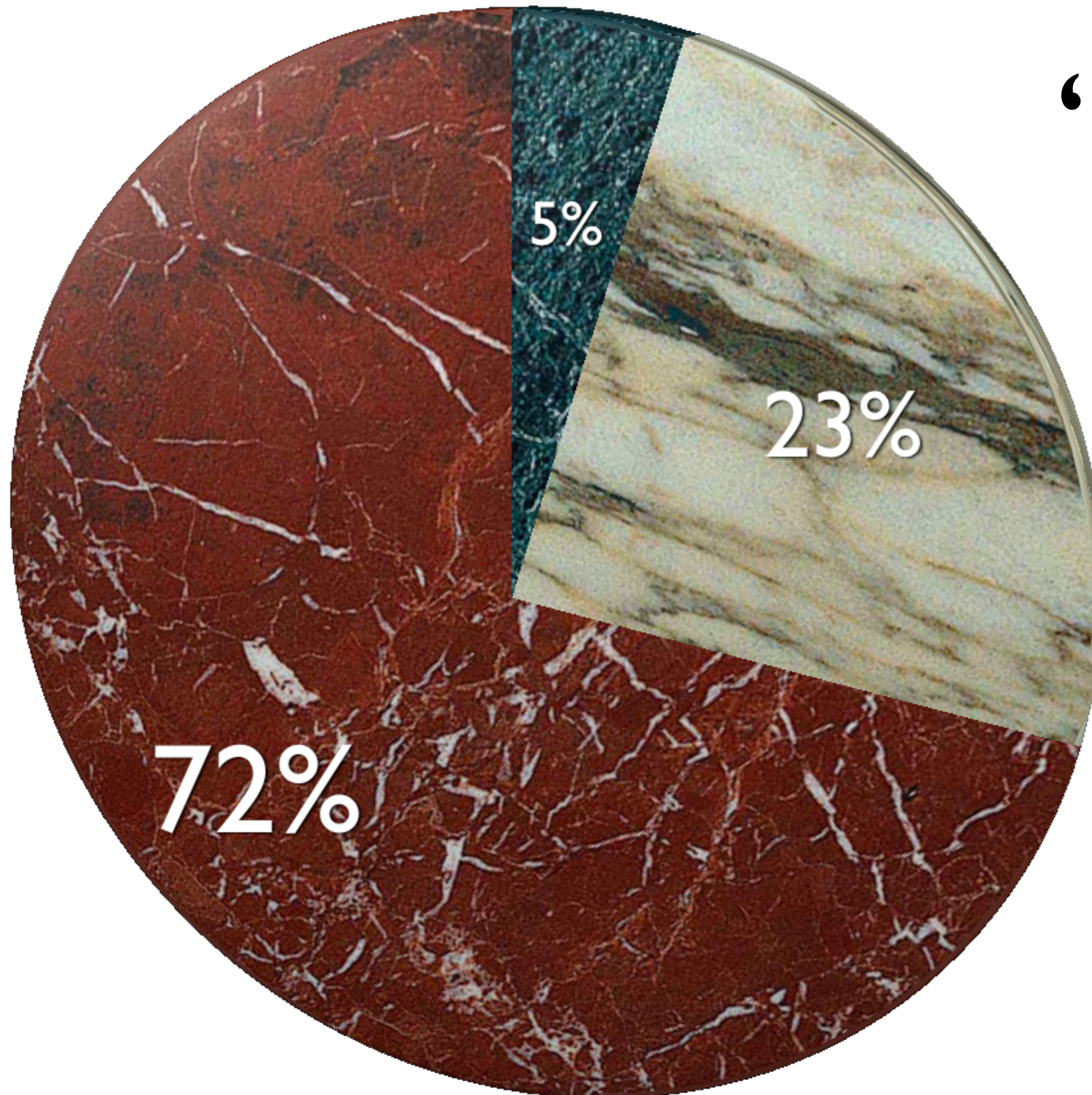

- Cosmological observations (CMB, galaxies, supernovae) over the last decade told us that **we don't understand much of the Universe.**



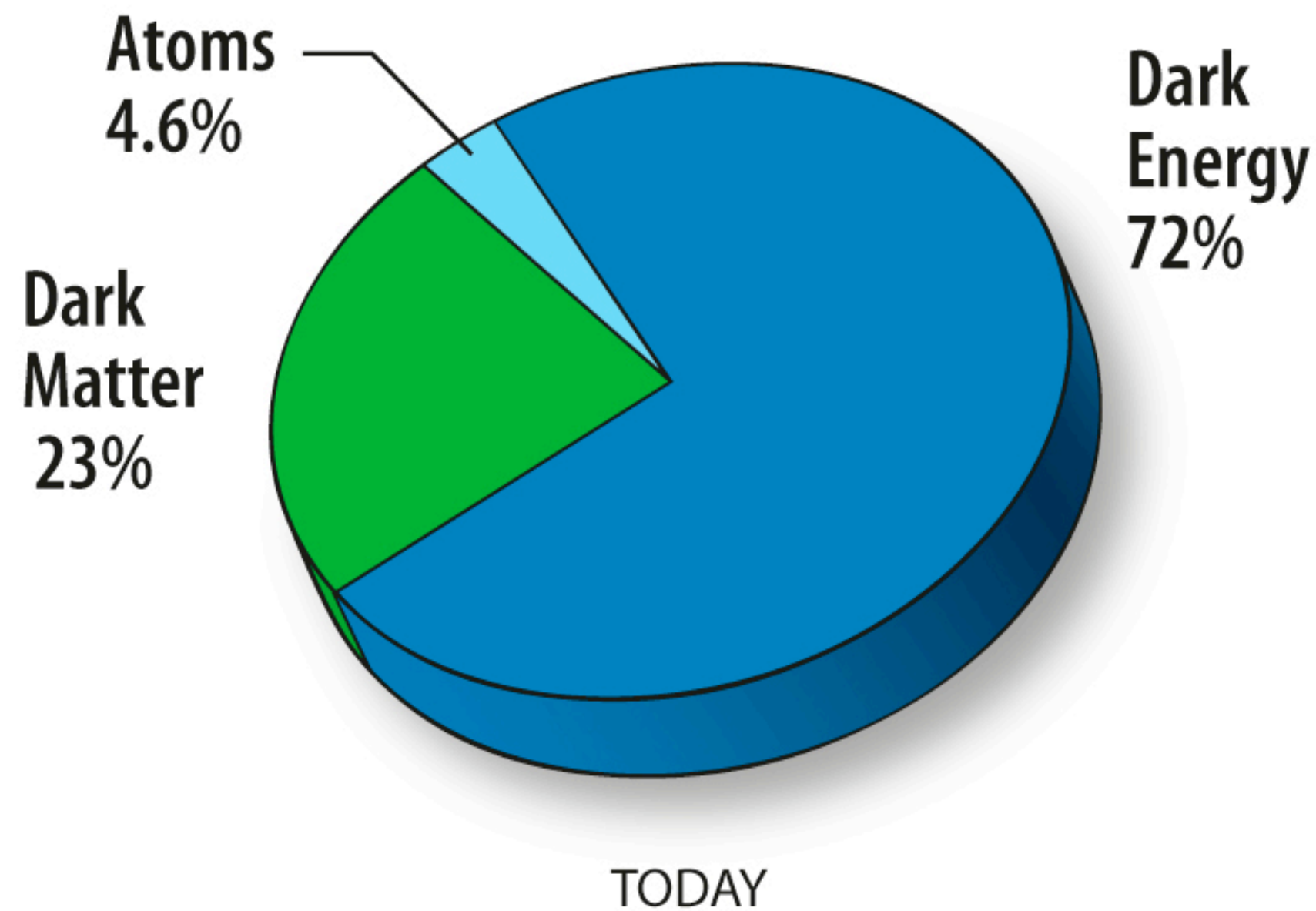

~WMAP 5-Year~ Pie Chart Update!

- Universe today

- Age: **13.72 ± 0.12** billion years

- Atoms: **4.56 ± 0.15** %

- Dark Matter: **22.8 ± 1.3** %

- Vacuum Energy: **72.6 ± 1.5** %

- When CMB was released 13.7 B yrs ago

- A significant contribution from the *cosmic neutrino background*

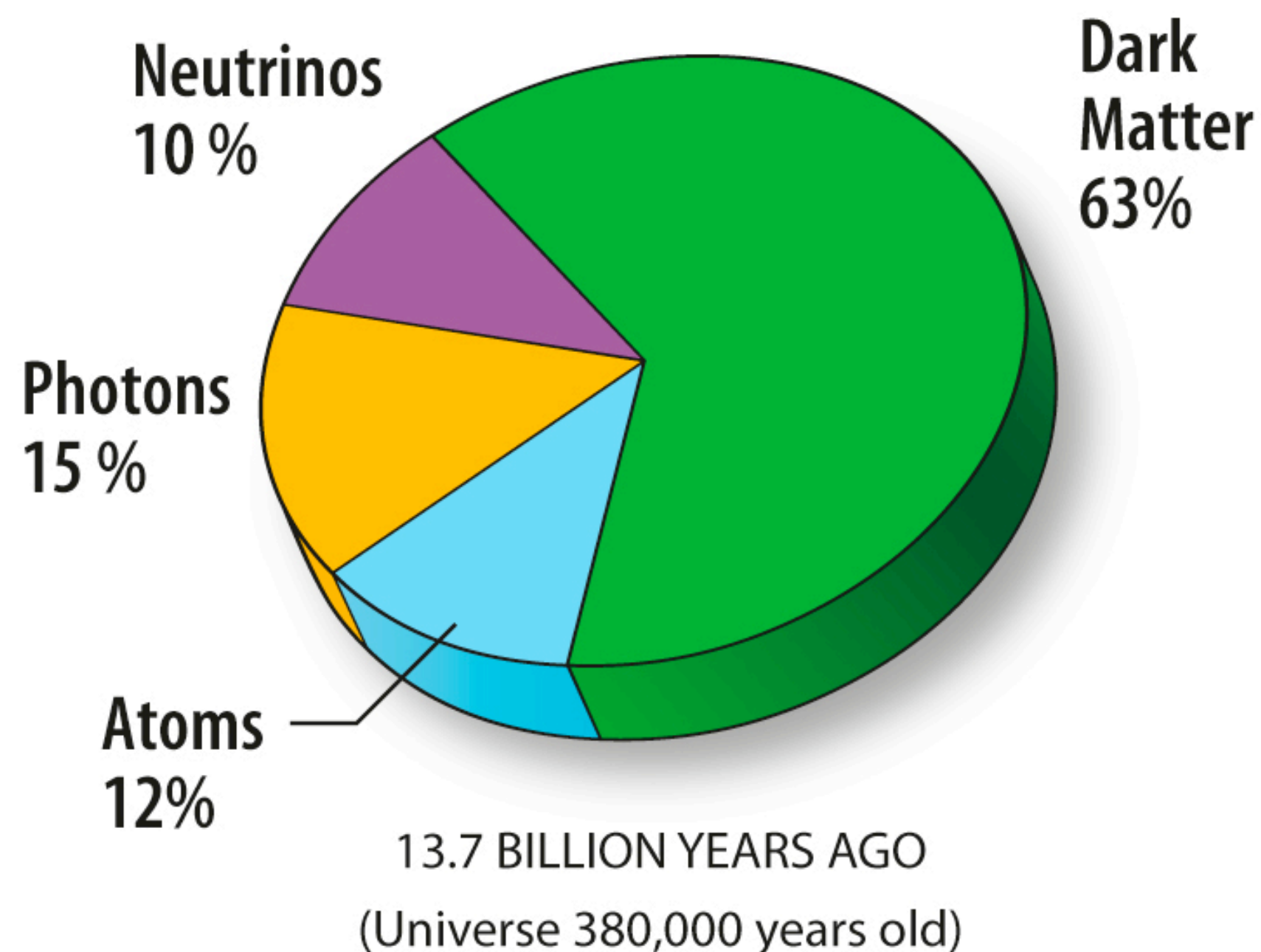

Golden Age of Cosmology

- **Q. Why Golden Age?**
- **A. Because we are facing extraordinary challenges.**
 - What is Dark Matter?
 - What is Dark Energy?

Even More Challenging

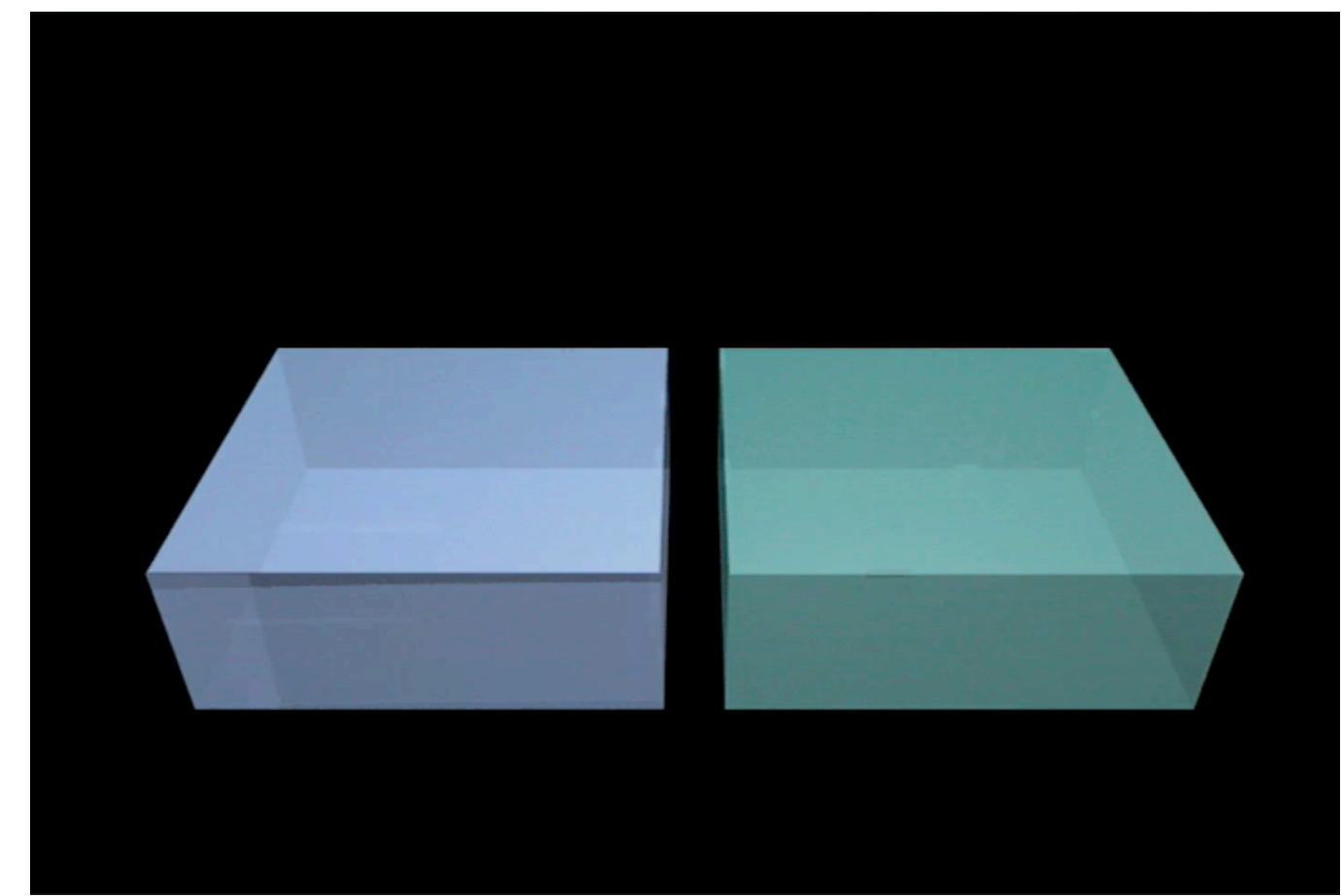

- OK, back to the cosmic waterzooi.
- The sound waves were created when we perturbed it.
- “We”? **Who?**
- Who actually dropped a spoon in the cosmic waterzooi?
- **Who generated the original (seed) ripples?**
 - ***We must go farther back in time to answer this question!***

Decoding the Primordial Ripples

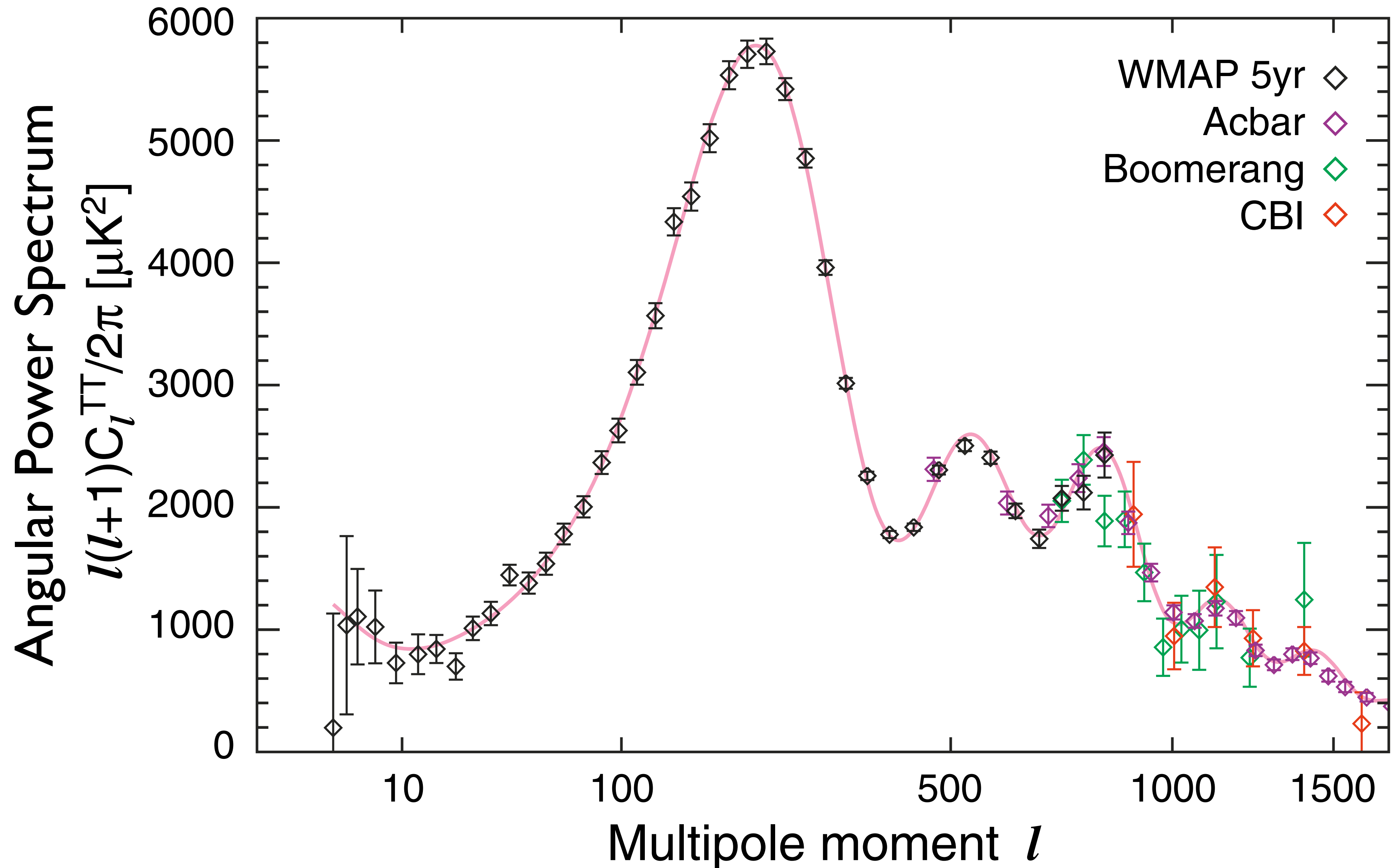

Getting rid of the Sound Waves

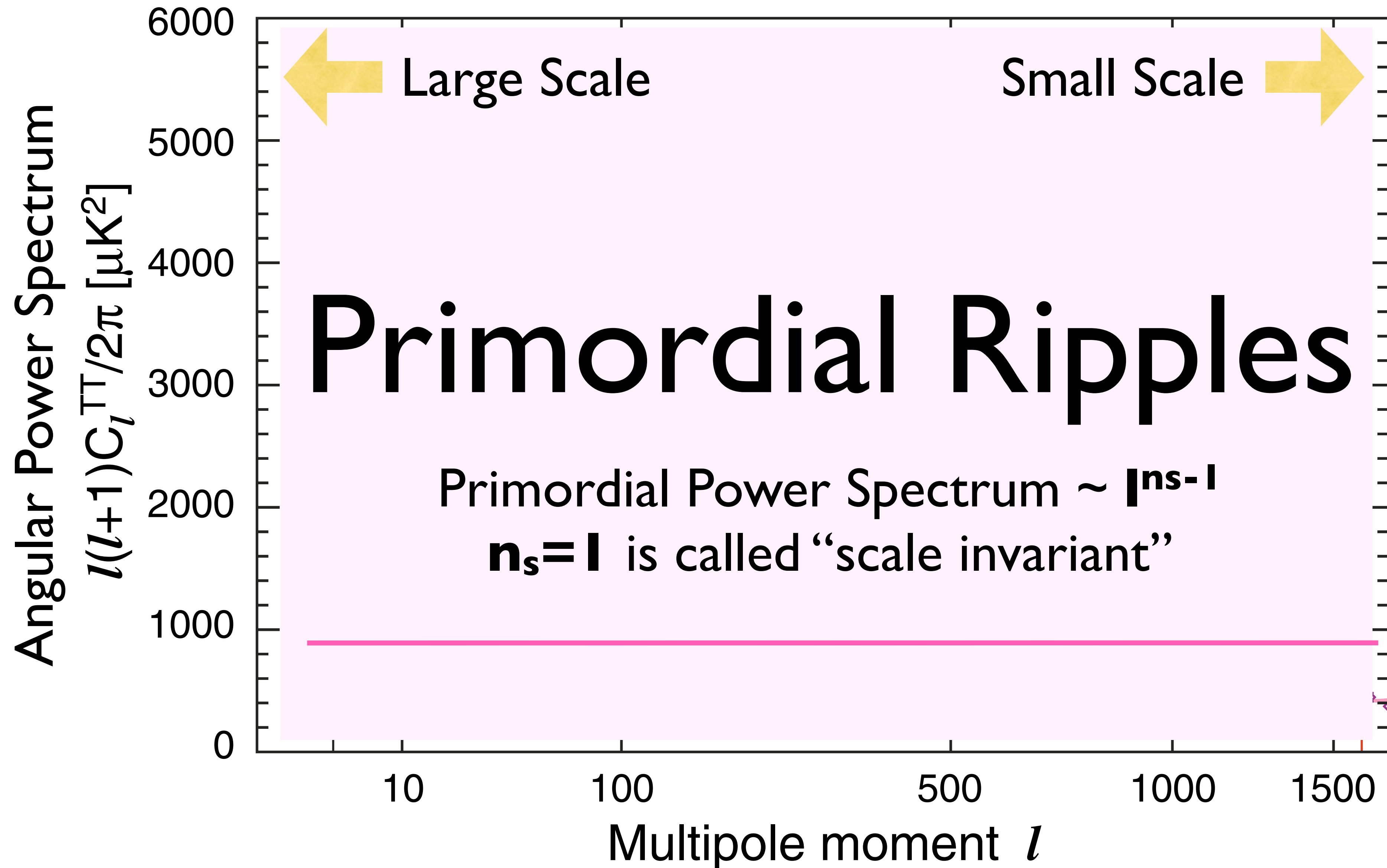

The Early Universe Could Have Done This Instead

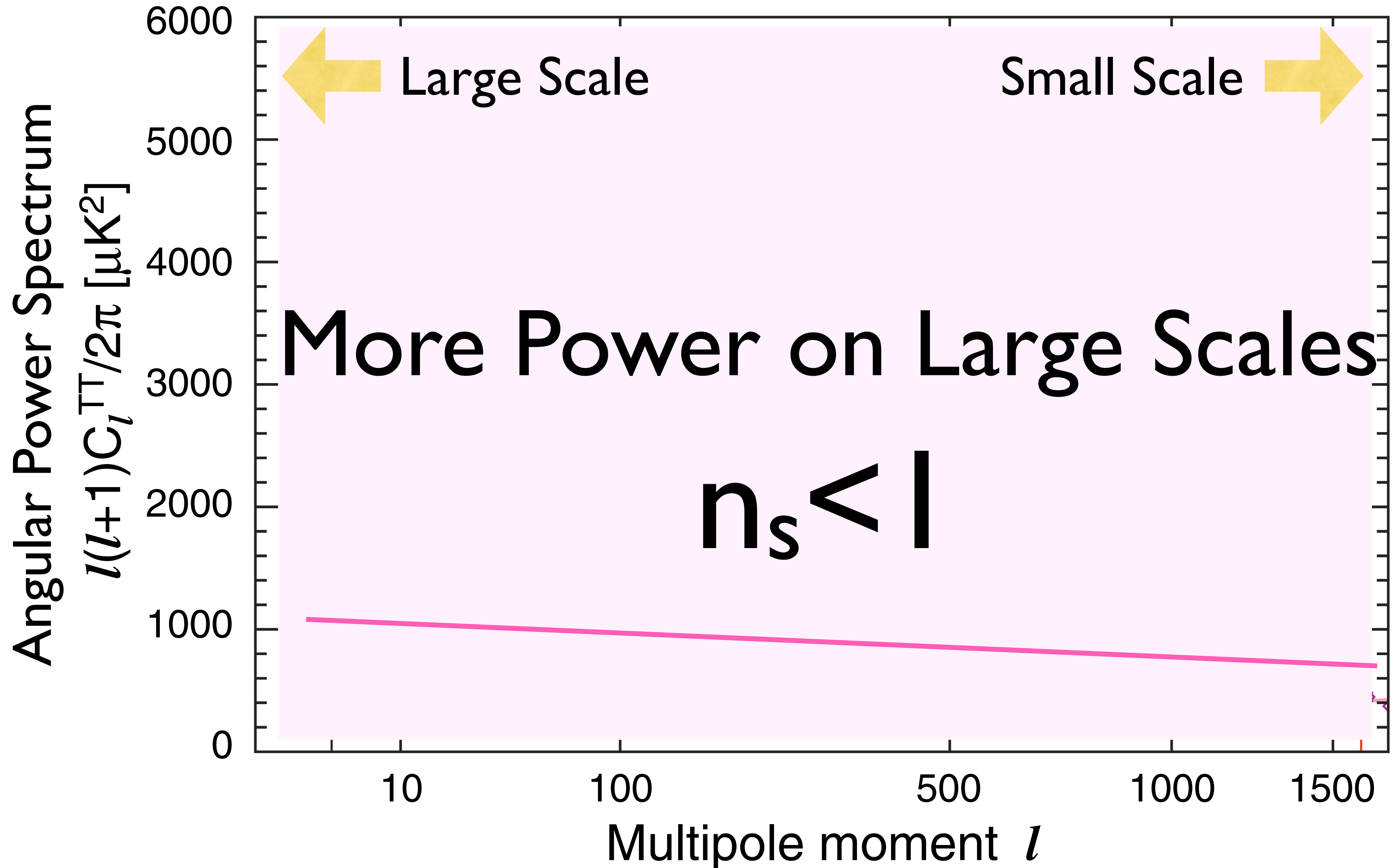

...or, This.

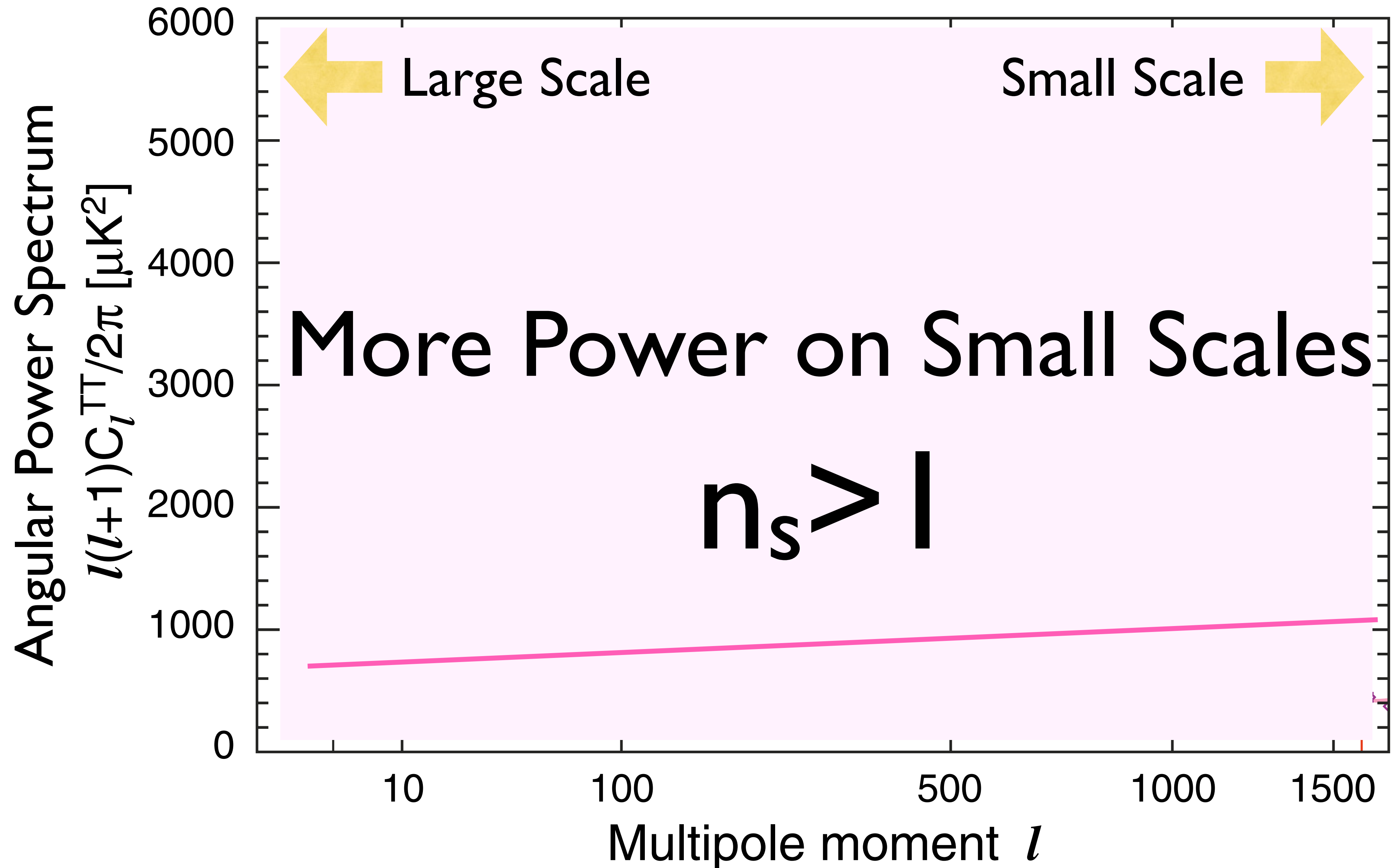

Theory of the Very Early Universe

- The leading theoretical idea about the primordial Universe, called “**Cosmic Inflation**,” predicts:
(Guth 1981; Linde 1982; Albrecht & Steinhardt 1982; Starobinsky 1980)
- The expansion of our Universe **accelerated** in a tiny fraction of a second after its birth.
- Just like Dark Energy accelerating today’s expansion: the acceleration also happened at very, very early times!
- **Inflation stretches “micro to macro”**
 - In a tiny fraction of a second, the size of an atomic nucleus ($\sim 10^{-15}\text{m}$) would be stretched to 1 A.U. ($\sim 10^{11}\text{m}$), at least.

Cosmic Inflation = Very Early Dark Energy

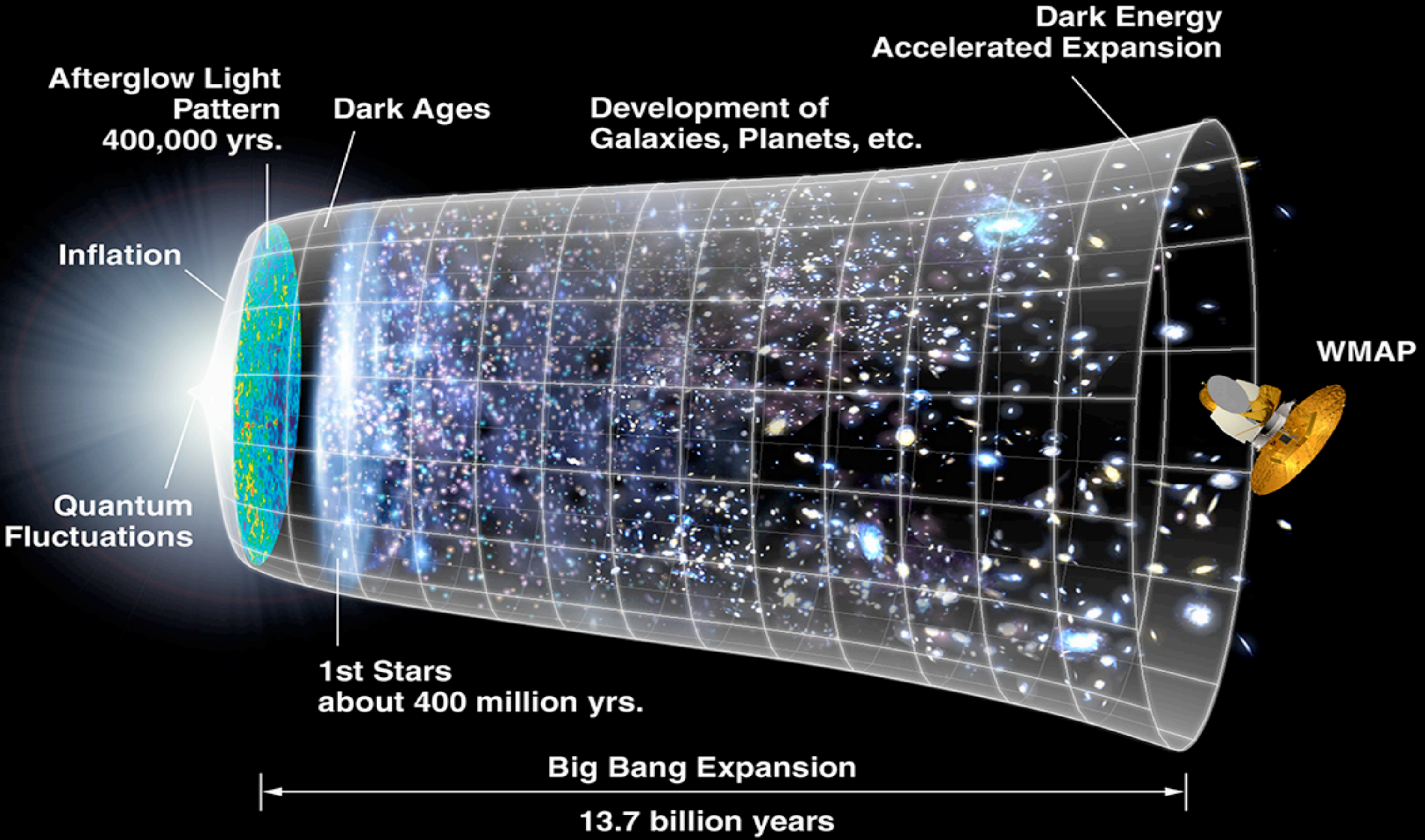

Theory Says...

- The leading theoretical idea about the primordial Universe, called “**Cosmic Inflation**,” predicts:
 - The expansion of our Universe **accelerated** in a tiny fraction of a second after its birth.
 - the primordial ripples were created by **quantum fluctuations** during inflation, and
 - how the power is distributed over the scales is determined by the expansion history during cosmic inflation.
- Detailed observations give us **this** remarkable information!

Quantum Fluctuations

- You may borrow a lot of **energy** from vacuum if you promise to return it to the vacuum immediately.
- The amount of **energy** you can borrow is inversely proportional to the time for which you borrow the **energy** from the vacuum.
- This is the so-called Heisenberg's Uncertainty Principle, which is the foundation of Quantum Mechanics.

*Mukhanov & Chibisov (1981); Guth & Pi (1982); Starobinsky (1982); Hawking (1982);
Bardeen, Turner & Steinhardt (1983)*

(Scalar) Quantum Fluctuations

$$\delta\varphi = (\text{Expansion Rate})/(2\pi) \text{ [in natural units]}$$

- Why is this relevant?
- The cosmic inflation (probably) happened when the Universe was a tiny fraction of second old.
 - Something like 10^{-36} second old
 - (Expansion Rate) $\sim 1/(\text{Time})$
 - which is a big number! ($\sim 10^{12}\text{GeV}$)
- *Quantum fluctuations were important during inflation!*

Stretching Micro to Macro

Macroscopic size at which gravity becomes important



Quantum fluctuations on microscopic scales

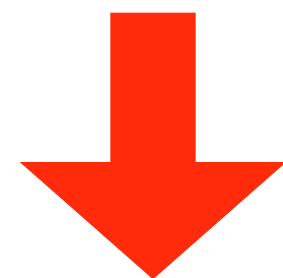

INFLATION!

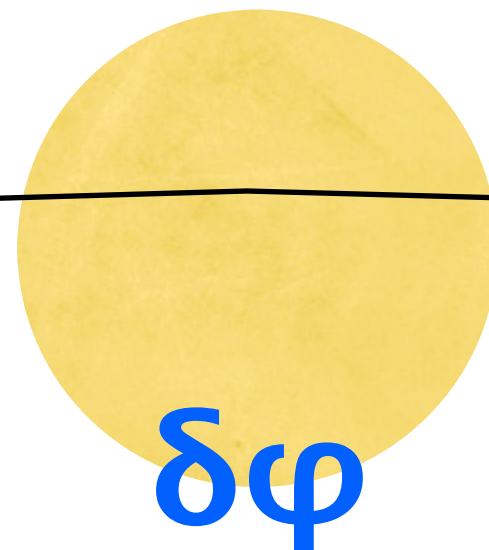

Quantum fluctuations cease to be quantum, and become observable!

Inflation Offers a Magnifier for Microscopic World

- Using the *power spectrum of primordial fluctuations* imprinted in CMB, we can observe the quantum phenomena at the ultra high-energy scales that would never be reached by the particle accelerator.

(Tensor) Quantum Fluctuations, a.k.a. Gravitational Waves

$$h = (\text{Expansion Rate}) / (2^{1/2} \pi M_{\text{planck}}) \text{ [in natural units]}$$

[h = “strain”]

- Quantum fluctuations also generate ripples in space-time, i.e., gravitational waves, by the same mechanism.
- Primordial gravitational waves generate temperature anisotropy in CMB, as well as polarization in CMB with a distinct pattern called “**B-mode polarization.**”

Gravitational Waves & Quadrupole

- As GW propagates in space, it stretches/contracts space.
 - Stretch -> Redshift -> **Lower temperature**
 - Contraction -> Blueshift -> **Higher temperature**

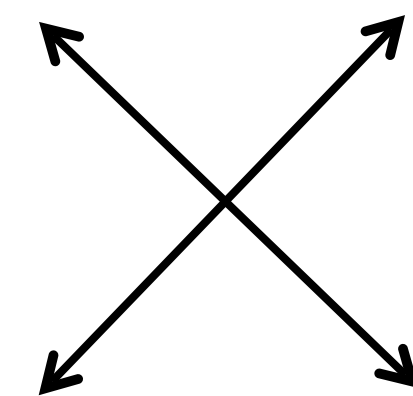
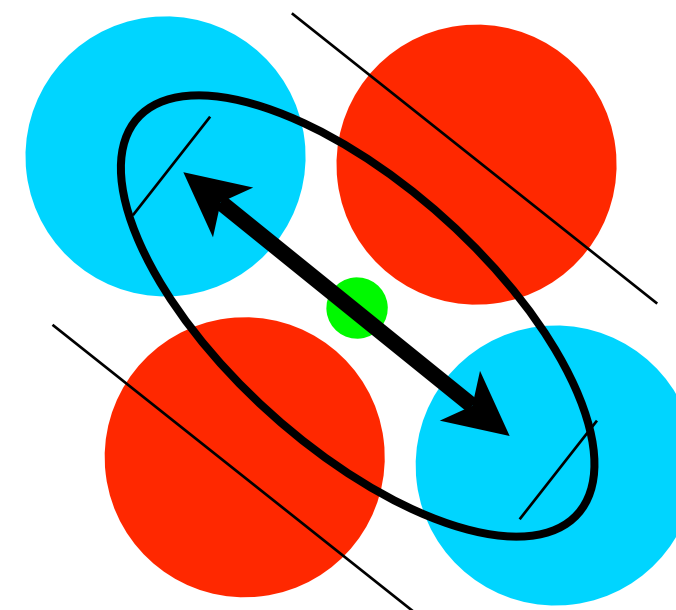
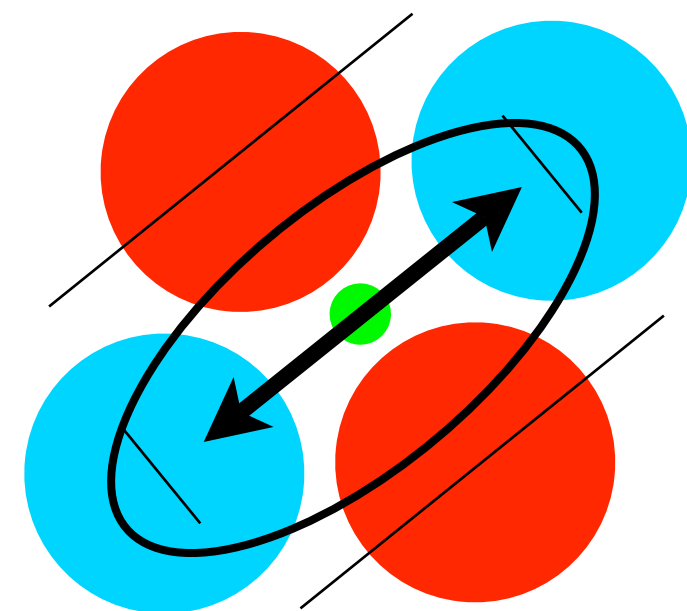
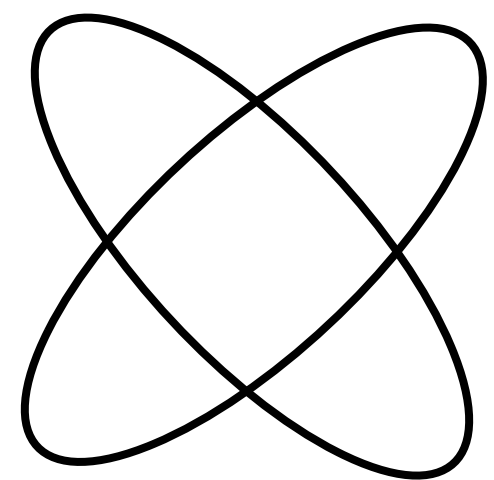
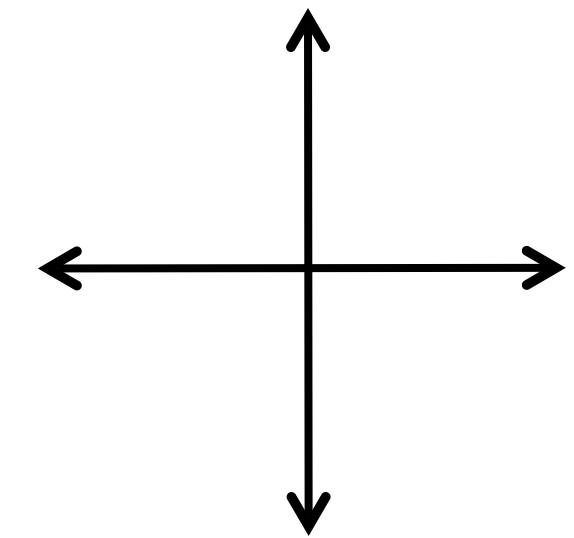
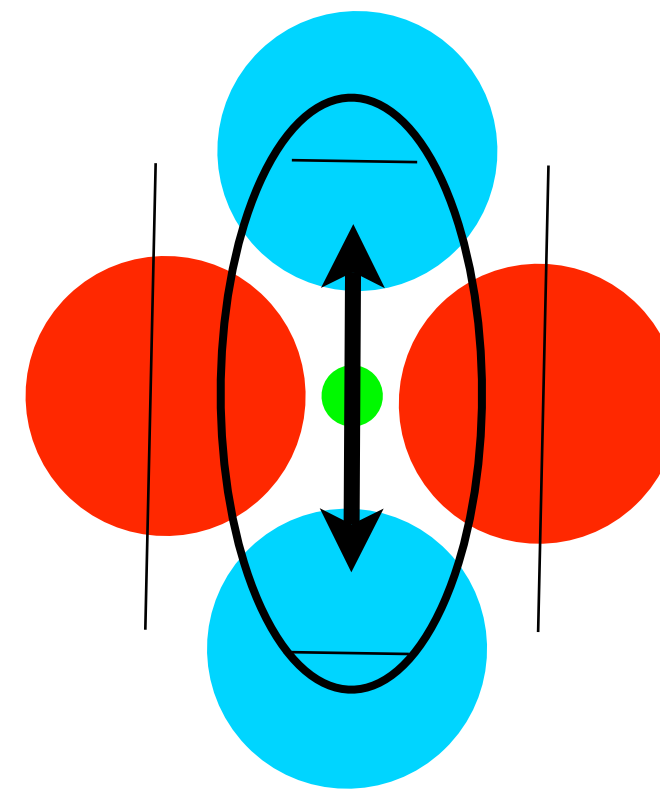
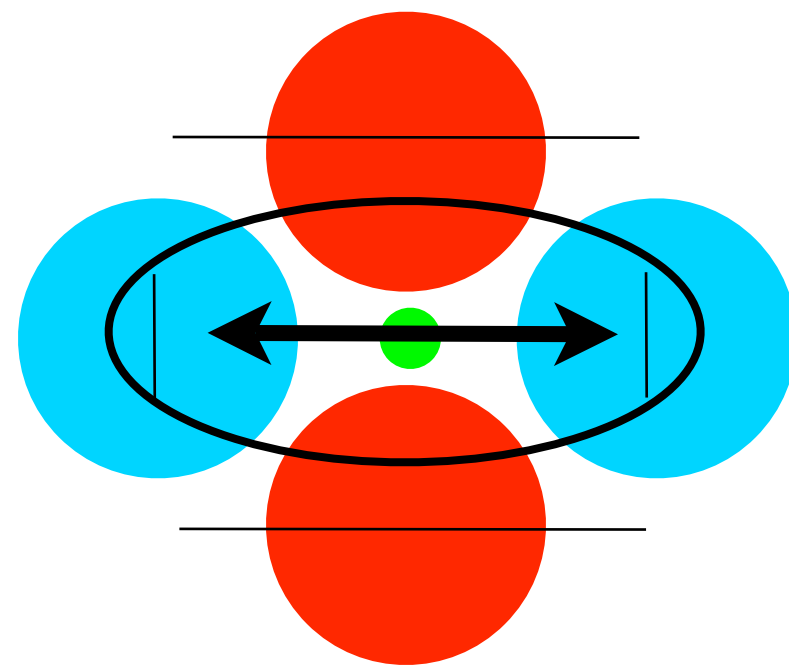
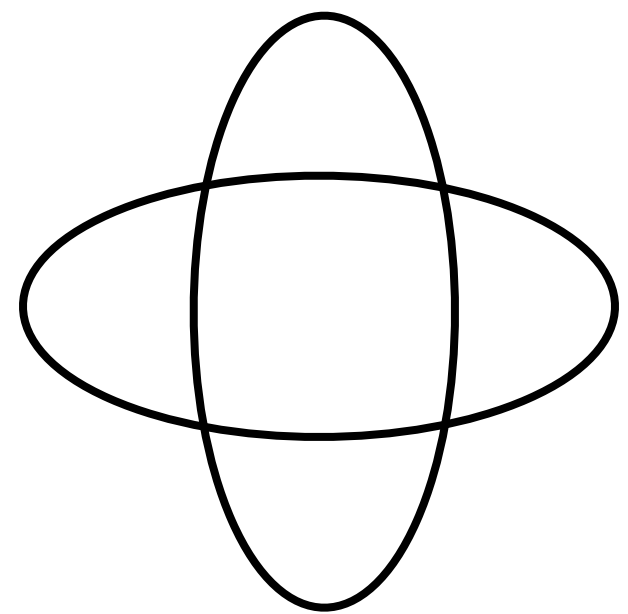

CMB Polarization

- Polarization is generated from an electron scattering, coupled with the quadrupolar radiation pattern around the electron.

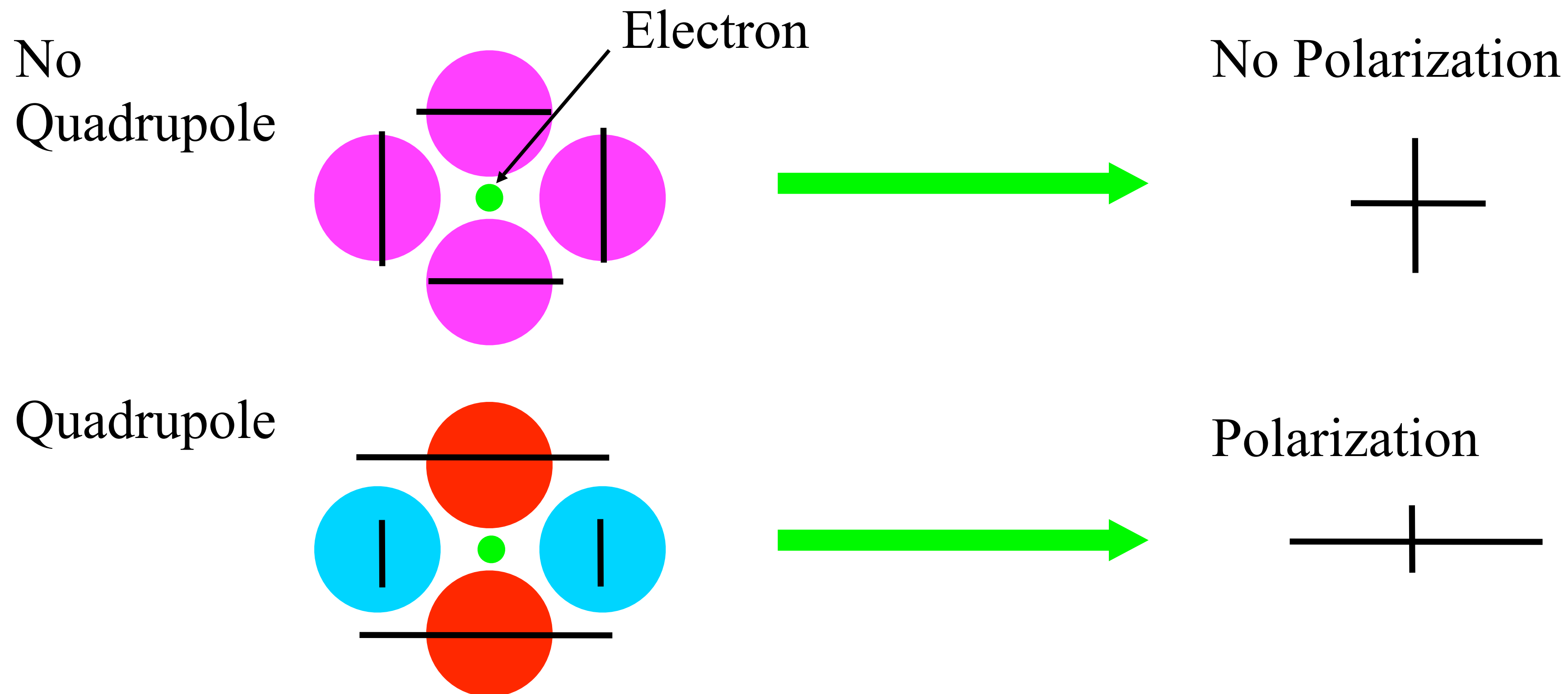

E-mode and B-mode Polarization

- Polarization has directions.
- One can decompose it into a divergence-like “E-mode” and a vorticity-like “B-mode”.

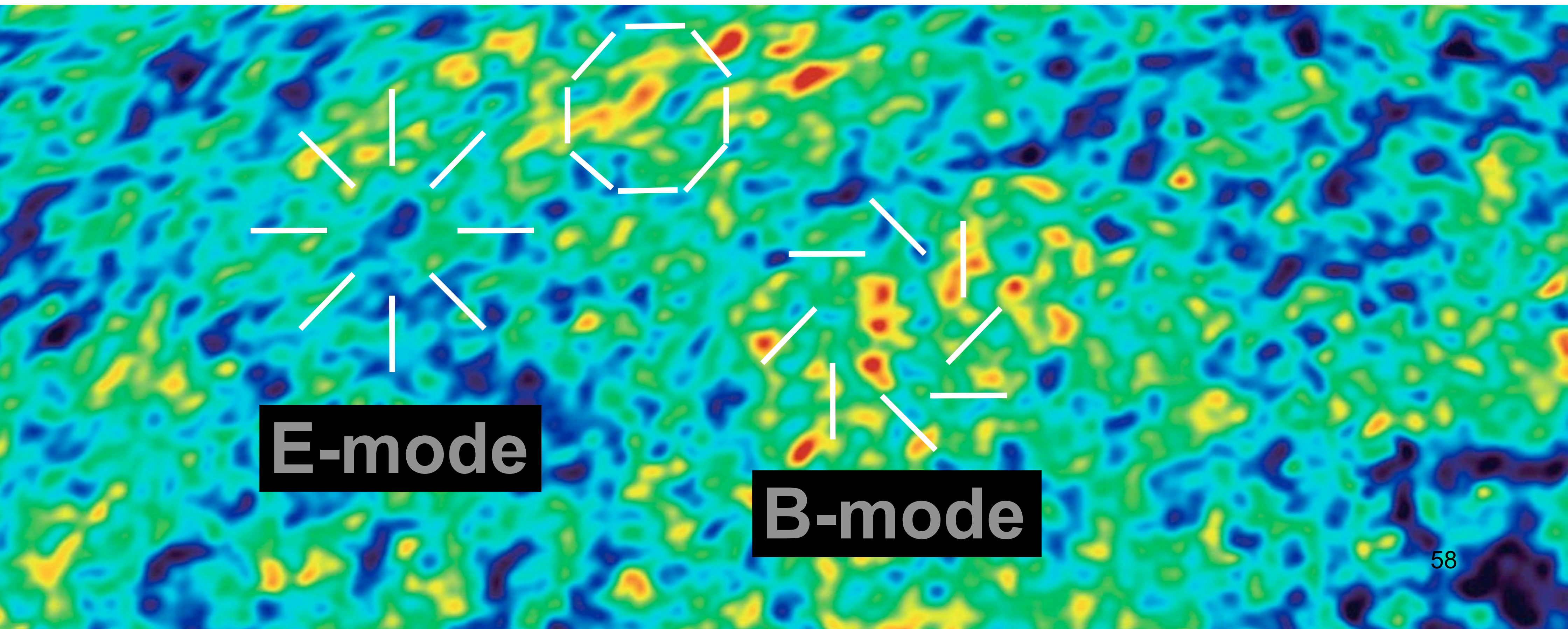

E-mode

B-mode

Polarization Anisotropy

Color:

Polarization Intensity

Line:

Polarization Direction

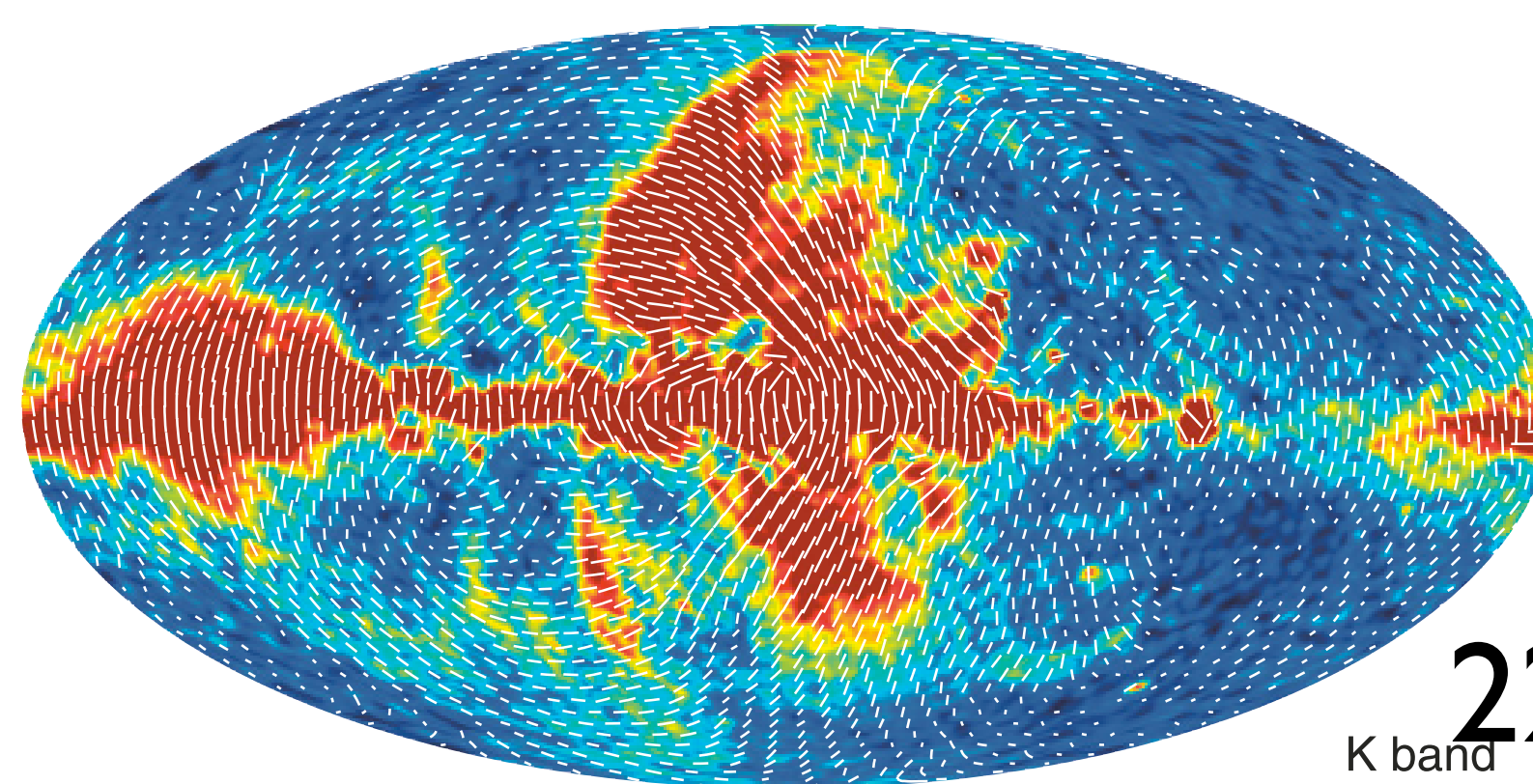

K band **22GHz**

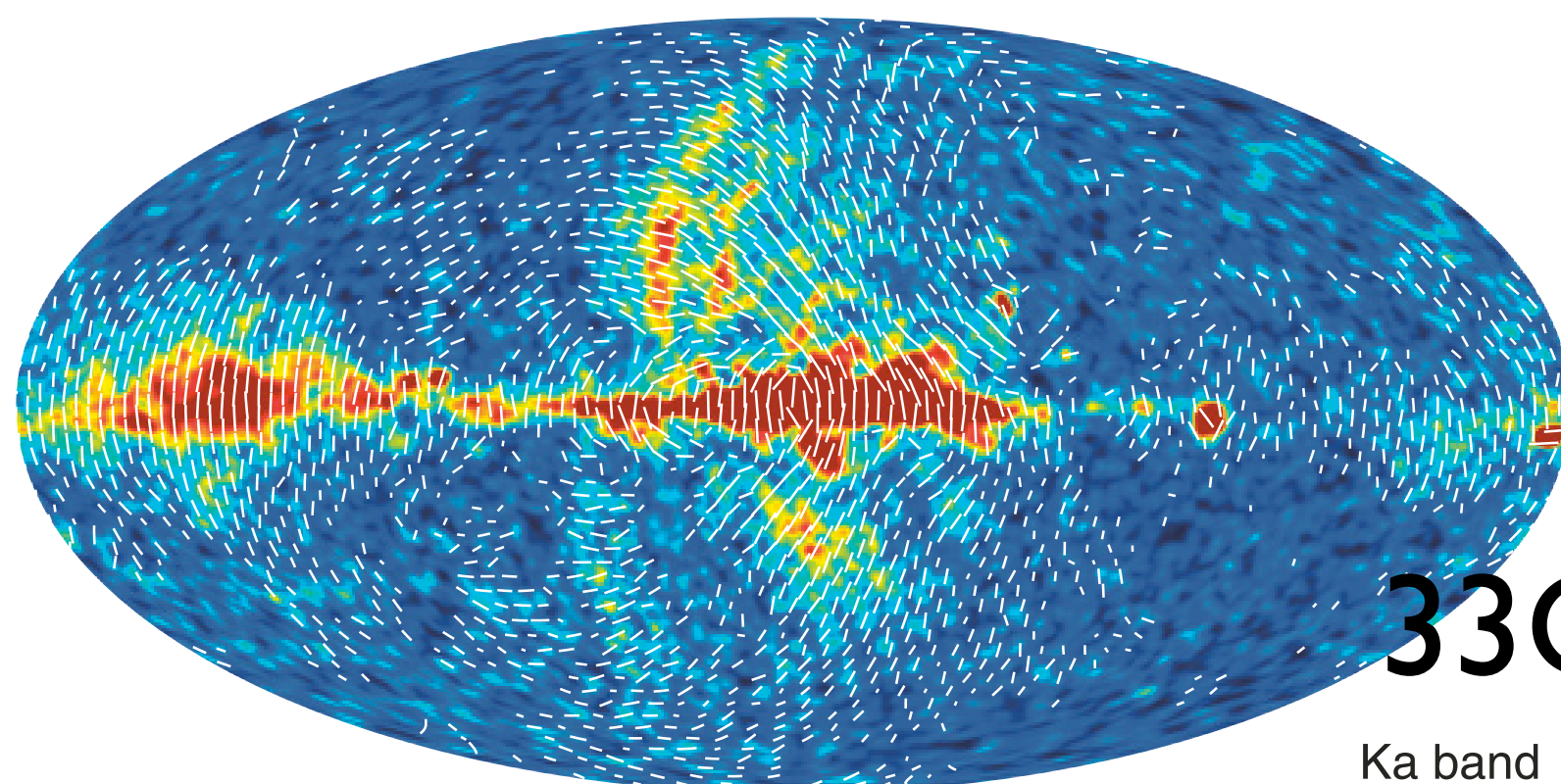
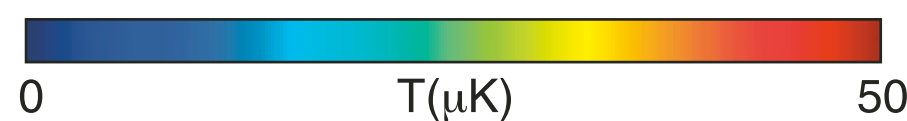

33GHz

Ka band

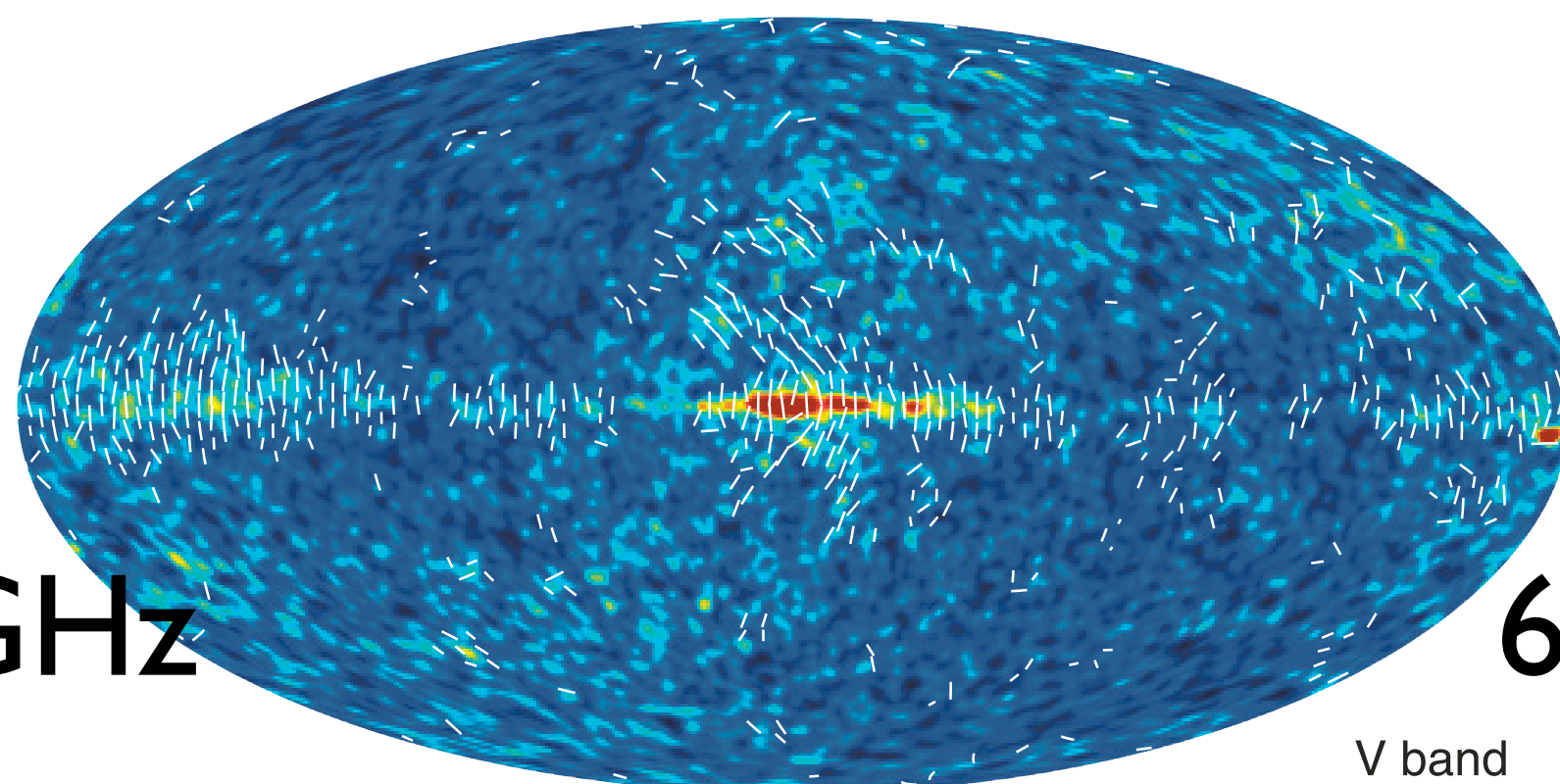

61GHz

V band

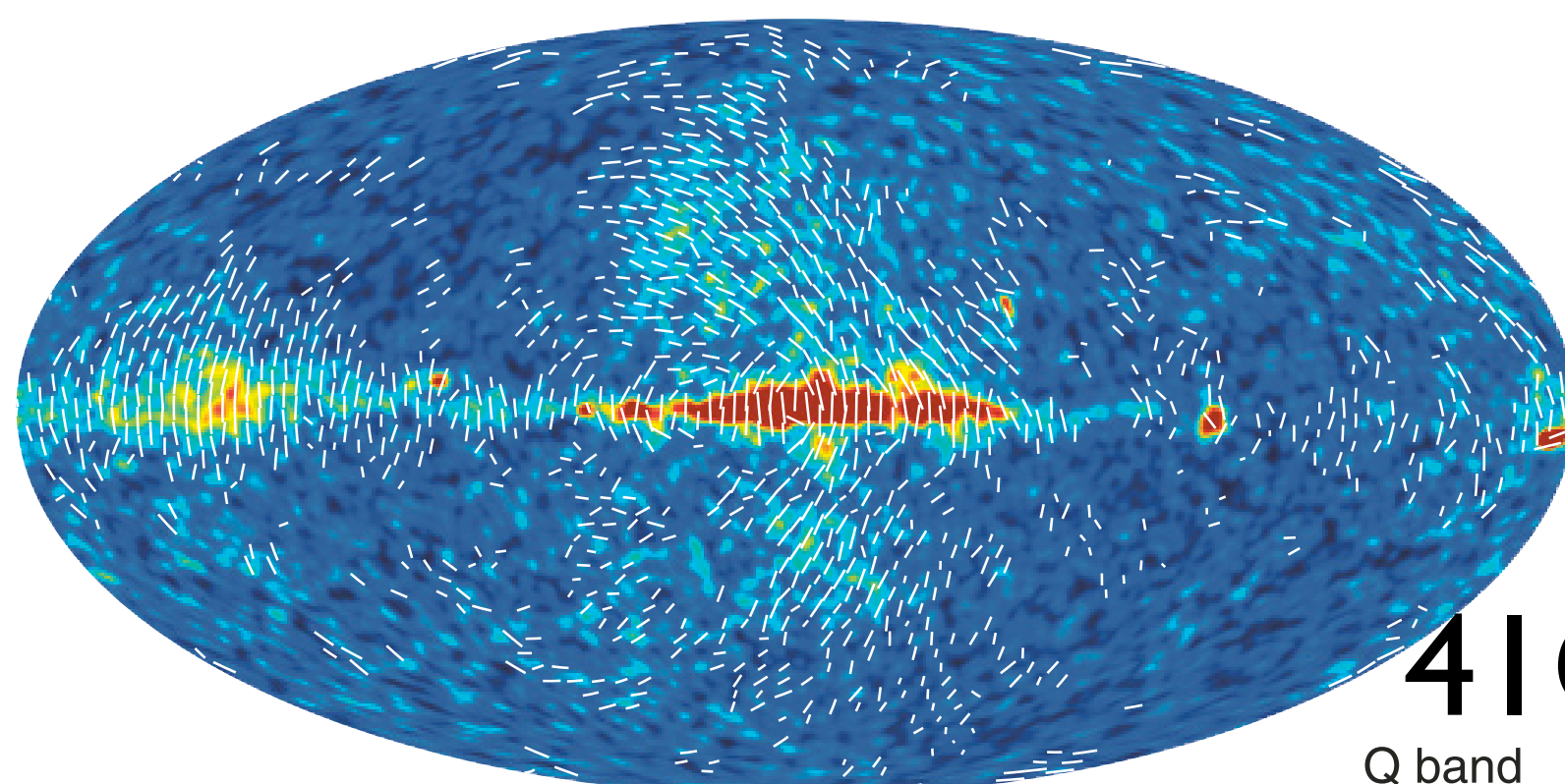

41GHz

Q band

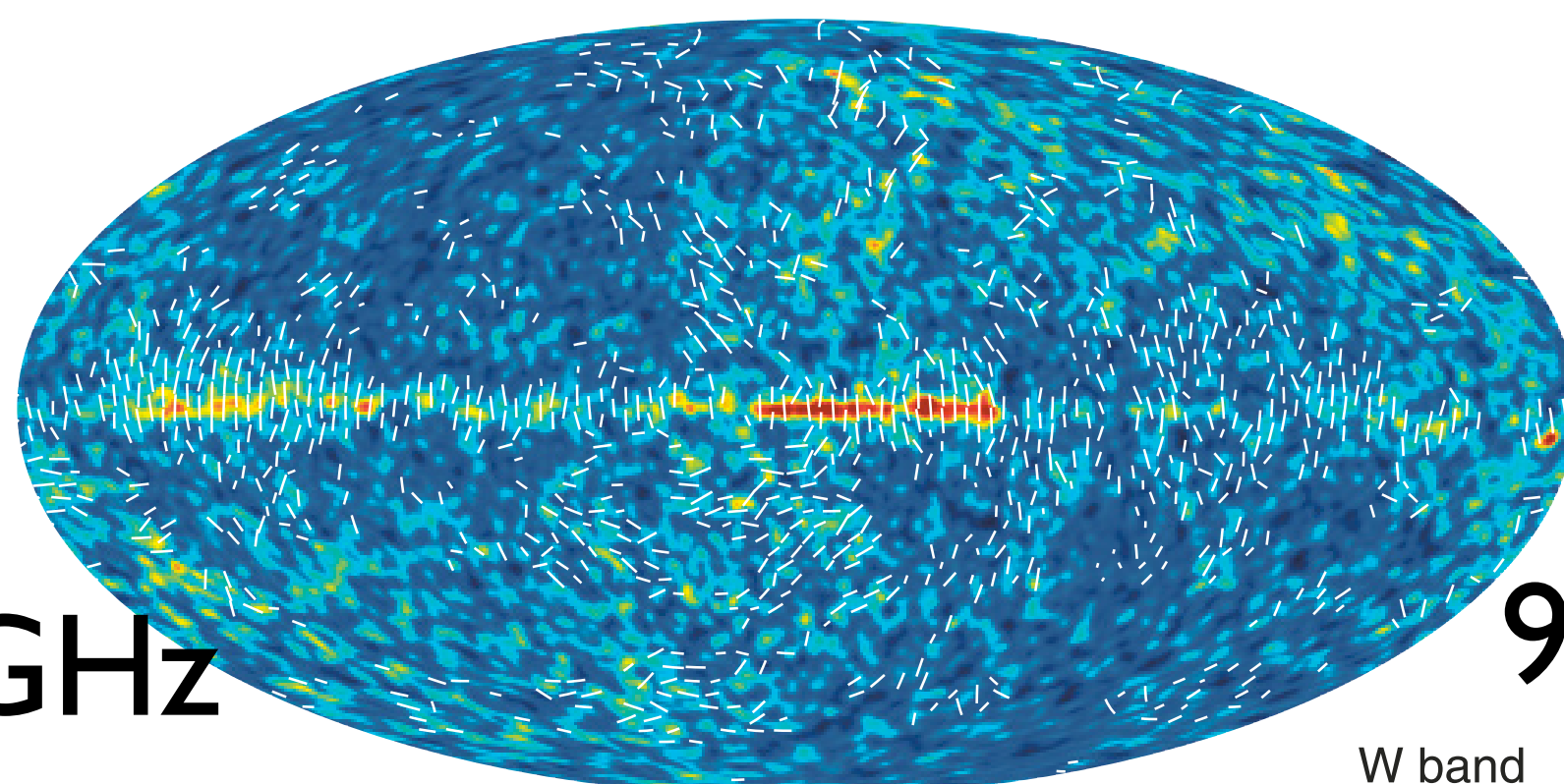

94GHz

W band

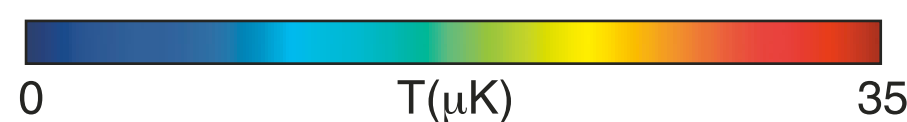

5-Year TxE Power Spectrum

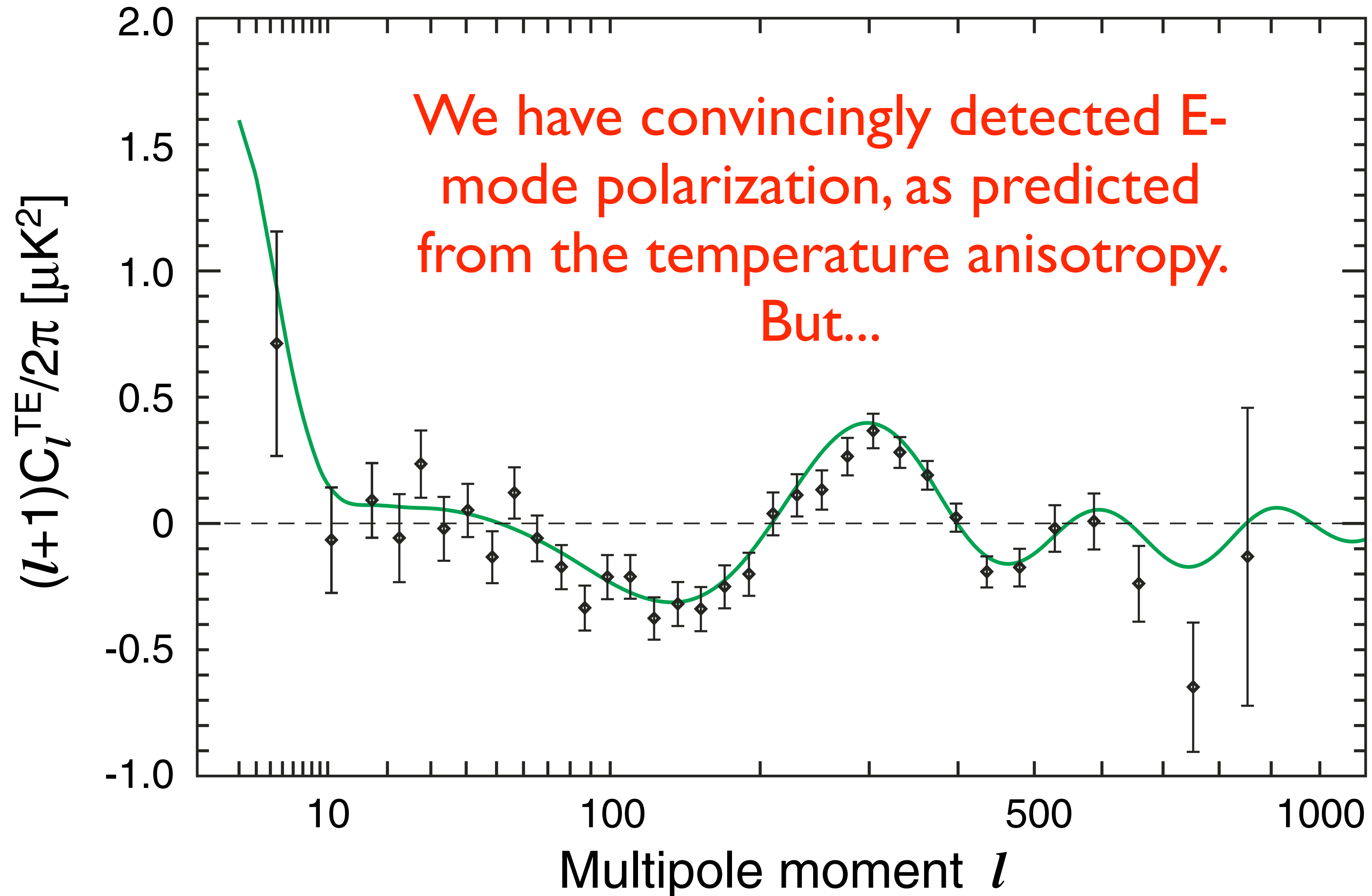

No Detection of B-modes (Yet)

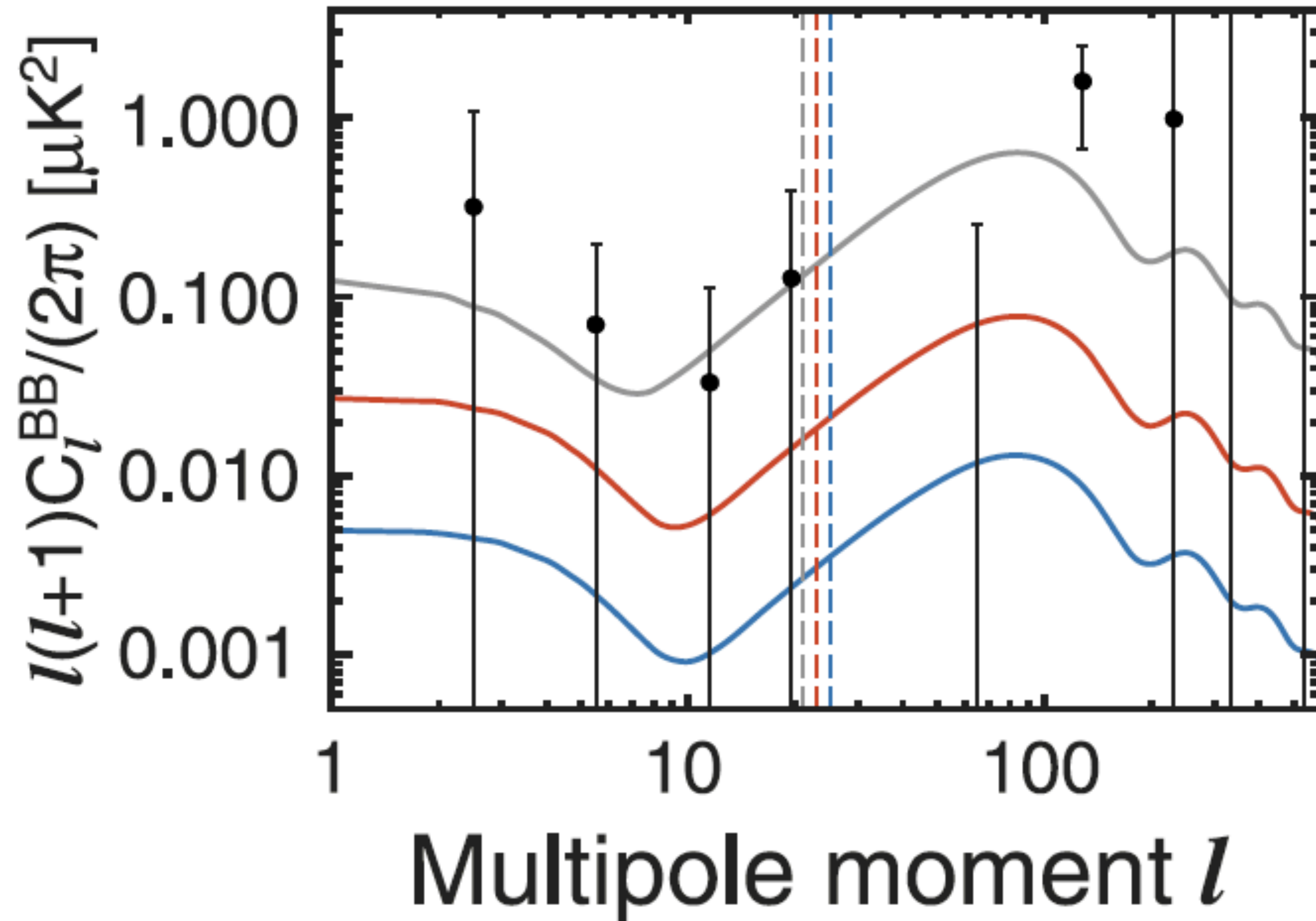

Testing Inflation

- $n_s = 0.960 \pm 0.013$ (68%CL)
- 3σ away from the exact scale invariance (which is favoured by many inflation models)
- **Tensor-to-scalar Ratio < 0.22 (95%CL)**
- Many inflationary models are still compatible with the current data.
- Many models have been excluded also: **observational test of inflation!**

Tensor-to-Scalar Ratio

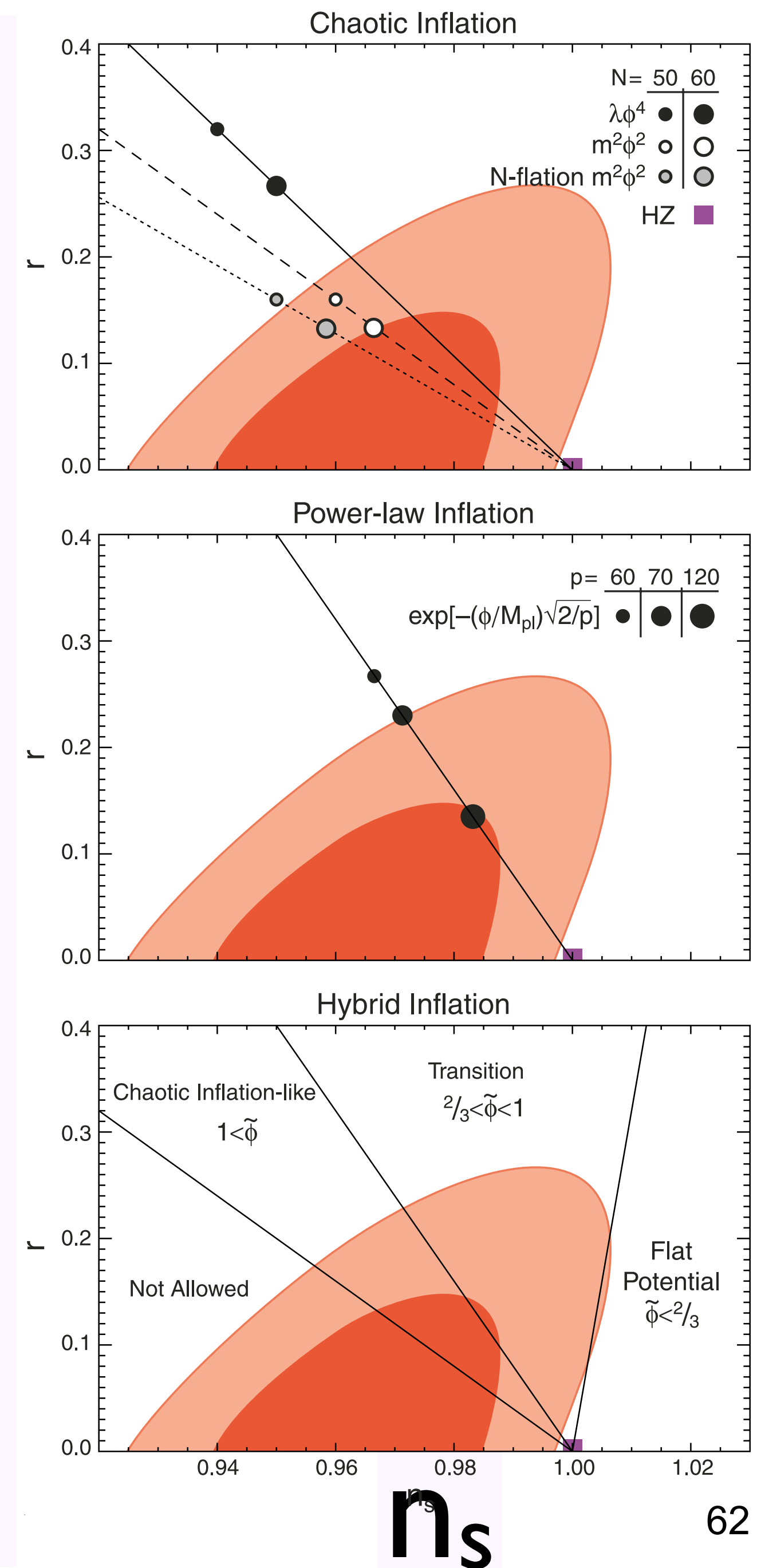

More to Learn: Beyond 2-pt Function

- So far, I have been talking only about what we learned from the 2-point correlation function, or the power spectrum.
- **How about a 3-point function, or the *bispectrum*?**
- There is potentially a lot more information out there - which is a sole topic of my presentation at the Solvay Workshop, “***Observational Frontiers in Fundamental Physics***.”
- This (3pt function) is currently one of the hottest field, and I will tell you why tomorrow, at 10:35am ;-)

Summary

- CMB is the fossil light of the Big Bang.
- We could determine the age, composition, expansion rate, etc., from CMB.
- We could even push the boundary farther back in time, probing the origin of fluctuations in the very early Universe: inflationary epoch at ultra-high energies.
- Next Big Thing(s): **Primordial gravitational waves**, and 3-point function (or more generally, we call it “**non-Gaussianity**”). See you tomorrow!